



Ireland

9 City Gate,
Lower Bridge Street,
Dublin 8

Tel: 01 633 4725
Fax: 01 633 4562

**DUBLIN CITY COUNCIL
DCC COUNTS
TRAFFIC SURVEY**

**SURVEY REPORT
MAY 2015**

| | |
|-------------|------------|
| PROJECT NO. | 5103 |
| CHECKED | P. MURRAY |
| DATE | 15/07/2015 |
| CONTACT | A.CHAMBERS |
| REVISION | |

CONTENTS

Introduction

Junction Turning Counts

Pedestrian Crossing Counts

Diagrams 5103-01 to 5103-11

Drawings 5103-01 to 5103-15

INTRODUCTION

Nationwide Data Collection (NDC) was instructed by Dublin City Council to undertake junction turning counts and pedestrian counts in various locations around Dublin City Centre.

General location plans are given in Diagrams 5103-01 to 5103-11.

JUNCTION TURNING COUNTS

Junction turning counts were undertaken at the following sites:

| Site No. | Location. | Days / Dates |
|----------|--|-------------------------------------|
| 1(5) | James Joyce Bridge (Blackhall Bridge) –NS | Wednesday 13 th May 2015 |
| 2(6) | James Joyce Bridge (Blackhall Bridge) - SS | |
| 3(17) | Butt Bridge - NS | Thursday 7 th May 2015 |
| 4(18) | Butt Bridge- SS | |
| 5(9) | Father Matthew Bridge (Church Street Bridge) –NS | Tuesday 12 th May 2015 |
| 6(10) | Father Matthew Bridge (Church Street Bridge) - SS | |
| 7(21) | East Link Bridge –NS | Wednesday 6 th May 2015 |
| 8(22) | East Link Bridge- SS | |
| 9(13) | Grattan Bridge (Capel Street) –NS | Tuesday 12 th May 2015 |
| 10(14) | Grattan Bridge (Capel Street) - SS | |
| 11(19) | Talbot Memorial (Memorial Bridge) –NS | Thursday 7 th May 2015 |
| 12(20) | Talbot Memorial (Memorial Bridge) - SS | |
| 13(15) | O'Connell Bridge–NS | |
| 14(16) | O'Connell Bridge- SS | Wednesday 13 th May 2015 |
| 15(7) | Mellow's Bridge (Queen Street Bridge) –NS | |
| 16(8) | Mellow's Bridge (Queen Street Bridge) - SS | |
| 17(1) | Frank Sherwin Bridge (Heuston Station) –NS | |
| 18(2) | Frank Sherwin Bridge (Heuston Station) - SS | |
| 19(3) | Rory O'Moore Bridge (Watling Street) –NS | |
| 20(4) | Rory O'Moore Bridge (Watling Street) - SS | Tuesday 12 th May 2015 |
| 21(11) | O'Donovan Rossa Bridge (Winetavern Street Bridge) –NS | |
| 22(12) | O'Donovan Rossa Bridge (Winetavern Street Bridge) - SS | Wednesday 6 th May 2015 |
| 23(27) | Samuel Beckett Bridge (Guild Street Bridge) –NS | |
| 24(28) | Samuel Beckett Bridge (Guild Street Bridge) - SS | Thursday 7 th May 2015 |
| 25 | Eustace Bridge (Leeson Street Bridge) –NS | |
| 26 | Eustace Bridge (Leeson Street Bridge) - SS | |
| 27 | Charlemont Bridge (Ranelagh Bridge) –NS | |
| 28 | Charlemont Bridge (Ranelagh Bridge) - SS | |
| 29 | Latouche Bridge (Portobello Bridge) –NS | |
| 30 | Latouche Bridge (Portobello Bridge) - SS | |
| 31 | Baggot Street Bridge –NS | Tuesday 5 th May 2015 |
| 32 | Baggot Street Bridge - SS | |
| 33 | Mount Street Bridge –NS | |
| 34 | Mount Street Bridge- SS | |

| Site No. | Location. | Days / Dates |
|----------|---|-------------------------------------|
| 35 | Lower Mount Street Bridge –NS | Tuesday 5 th May 2015 |
| 36 | Lower Mount Street Bridge - SS | |
| 37 | General McMahon Bridge (Pearse Street/Ringsend Road)–NS | Wednesday 6 th May 2015 |
| 38 | General McMahon Bridge (Pearse Street/Ringsend Road)- SS | |
| 43(23) | Cuffe Street / Cuffe Lane | Tuesday 12 th May 2015 |
| 44(24) | Dame Street / South Great George's Street | Wednesday 13 th May 2015 |
| 45(25) | Parnell Street / Dominick Street Lower | Tuesday 12 th May 2015 |
| 46(26) | Lombard Street East / Pearse Street / Westland Row | Wednesday 6 th May 2015 |
| 47 | Grand Canal Lower(NW) / Clanwilliam Place / Grand Canal Lower(SE) | Tuesday 5 th May 2015 |
| 48 | Clanwilliam Terrace / Grand Canal Lower(NW) / Grand Canal Lower(SE) | |
| 49 | Grand Canal Street Upper/Haddington Road/Shelbourne Road/Bath Avenue/South Lotts Road | |
| 50 | South Docks Road / Ringsend Road / South Lotts Road / Bridge Street | |
| 51 | Luke Kelly Bridge (Ballybough Road) –NS | Thursday 7 th May 2015 |
| 52 | Luke Kelly Bridge (Ballybough Road) - SS | |
| 53 | Ranelagh Road(NW) / Charleston Road / Ranelagh Road(SE) / Ranelagh Avenue | |
| 54 | St Margarets Road(N) / Lidl Access / St Margarets Road(SW) / McKee Avenue | Tuesday 12 th May 2015 |
| 55 | Ranelagh Road(NW) / Elmwood Avenue Lower / Ranelagh Road(SE) / Westmoreland Park | Thursday 7 th May 2015 |
| 56 | Ranelagh Road(NW) / Elmpark Avenue / Ranelagh Road(SE) / Chelmsford Road | |
| 57 | Bath Street / Church Avenue(SW) / Beach Road / Church Avenue(NE) | Wednesday 6 th May 2015 |
| 58 | Pembroke Street/Church Avenue/Beach Road/Sean Moore Road | |
| 59 | Sean Moore Road / Beach Road(NW) / Cranfield Place / Beach Road(SE) | |
| 60 | R114(N) / Leinster Road / R114(S) | Thursday 7 th May 2015 |
| 61 | Marlborough Street / Eden Quay(W) / Rosie Hackett Bridge / Eden Quay(E) | |
| 62 | Rosie Hackett Bridge / Burgh Quay(W) / Hawkins Street / Burgh Quay(E) | |

(NS: Northside, SS: Southside)

(Site nos. As per DCC Cycle forum)

All sites were surveyed using telescopically mounted video cameras from which the information was subsequently extracted. Details of the observed movements are given in Drawings 5103-01 to 5103-15.

The survey was carried out with survey hours of 07:00 to 19:00. All information was collected in 15 minute intervals and has been tabulated with both hourly and period totals.

Vehicles were classified into the following categories:

- Cars (**CAR**)
- Light Goods Vehicles (**LGV**),
- Heavy Goods Vehicles – 2 axles(**HGV 2X**),
- Heavy Goods Vehicles – 3 axles(**HGV 3X**),
- Heavy Goods Vehicles – 4 axles(**HGV 4X**),
- Heavy Goods Vehicles – 5+ axles(**HGV 5+X**),
- Dublin Buses (**DBUS**),
- Other Buses (**OBUS**),
- Taxi (**TAXI**)
- Motorcycles (**M/C**) and
- Pedal Cycles (**P/C**).

PEDESTRIAN CROSSING COUNTS

Two-way pedestrian crossing counts were undertaken in 15 minute intervals, and tabulated with both hourly and period totals.

Arm labelling are shown in Drawings 5103-01 to 5103-15. Some of the sites are not consistent with the JTC Drawings and additional drawings have been provided within the results.

Additional pedestrian counts were also undertaken at the following sites:

| Site No. | Location. | Days / Dates |
|----------|---------------------------------------|------------------------------------|
| 39 | Footbridge (Sean O'Casey Footbridge)* | Wednesday 6 th May 2015 |
| 40 | Footbridge (Sean O'Casey Footbridge)* | |
| 41(29) | Footbridge (Millennium Bridge)* | Tuesday 12 th May 2015 |
| 42(30) | Footbridge (Millennium Bridge)* | |

*includes Pedal Cycles (**P/C**).

SITE REPORT

| | |
|----------------------------|---|
| Weather | Clear and sunny over the survey period. |
| Accidents | None. |
| Roadworks | None. |
| Queues | Various queuing throughout the network, particularly at peak periods. |
| Pedestrians | Recorded. |
| General Site Notes. | None. |

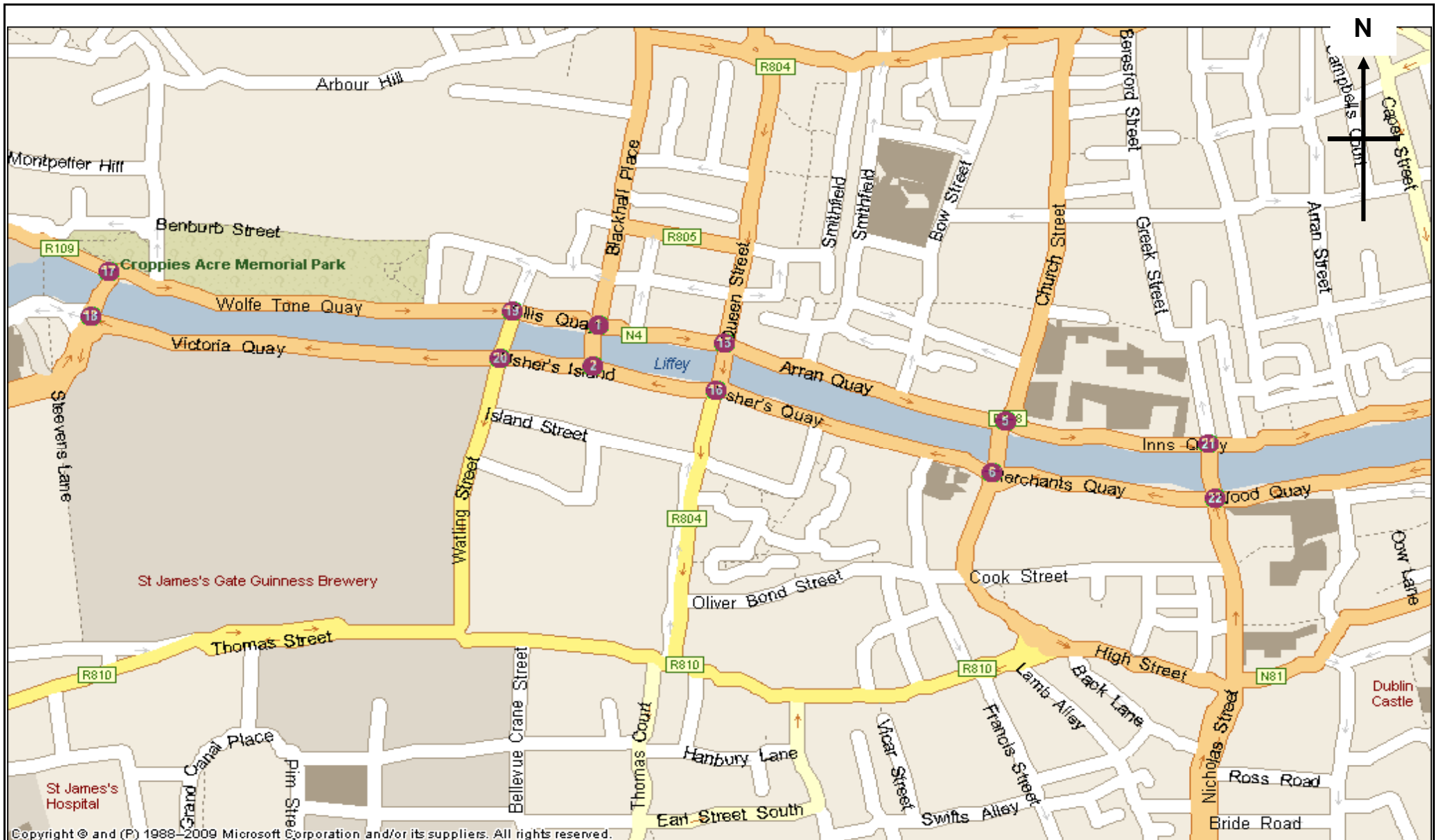

Copyright © and (P) 1998–2009 Microsoft Corporation and/or its suppliers. All rights reserved.

| | | | | |
|---|---|---|-----------------------------|---------------------|
|  | Sites / Location: 1, 2, 5, 6, 15 to 22 | Project No.: 5103 | Diagram No.: 5103-01 | Drawn By: AC |
| | Survey Date: Sites 1, 2, 15 to 20: Wednesday 13th May 2015 Sites 5, 6, 21 & 22: Tuesday 12th May 2015 | Project Name: DCC COUNTS 2015 | | |
| | Survey Times: 07:00 to 19:00 | Diagram Title: General Location Plan | | |

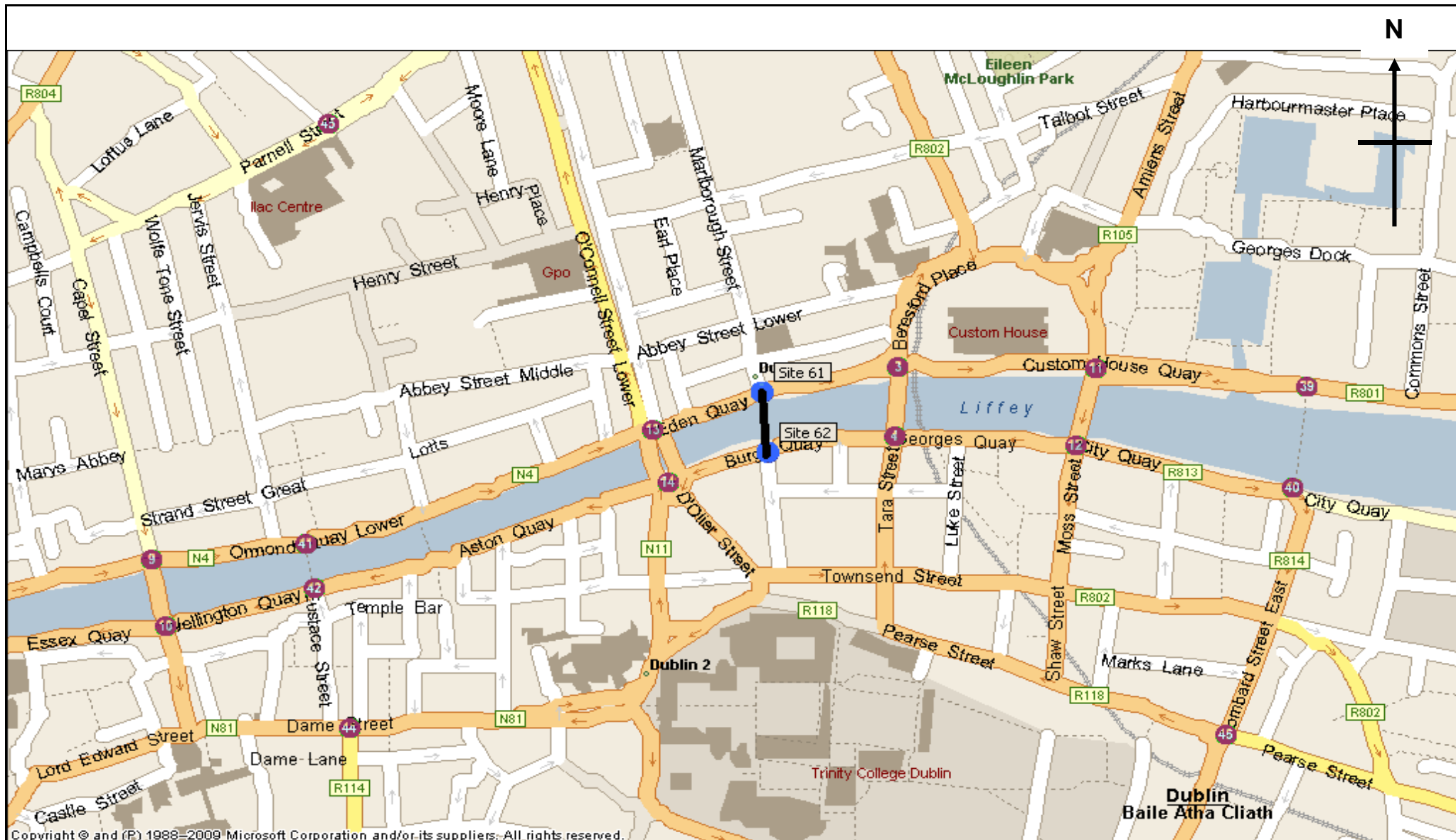

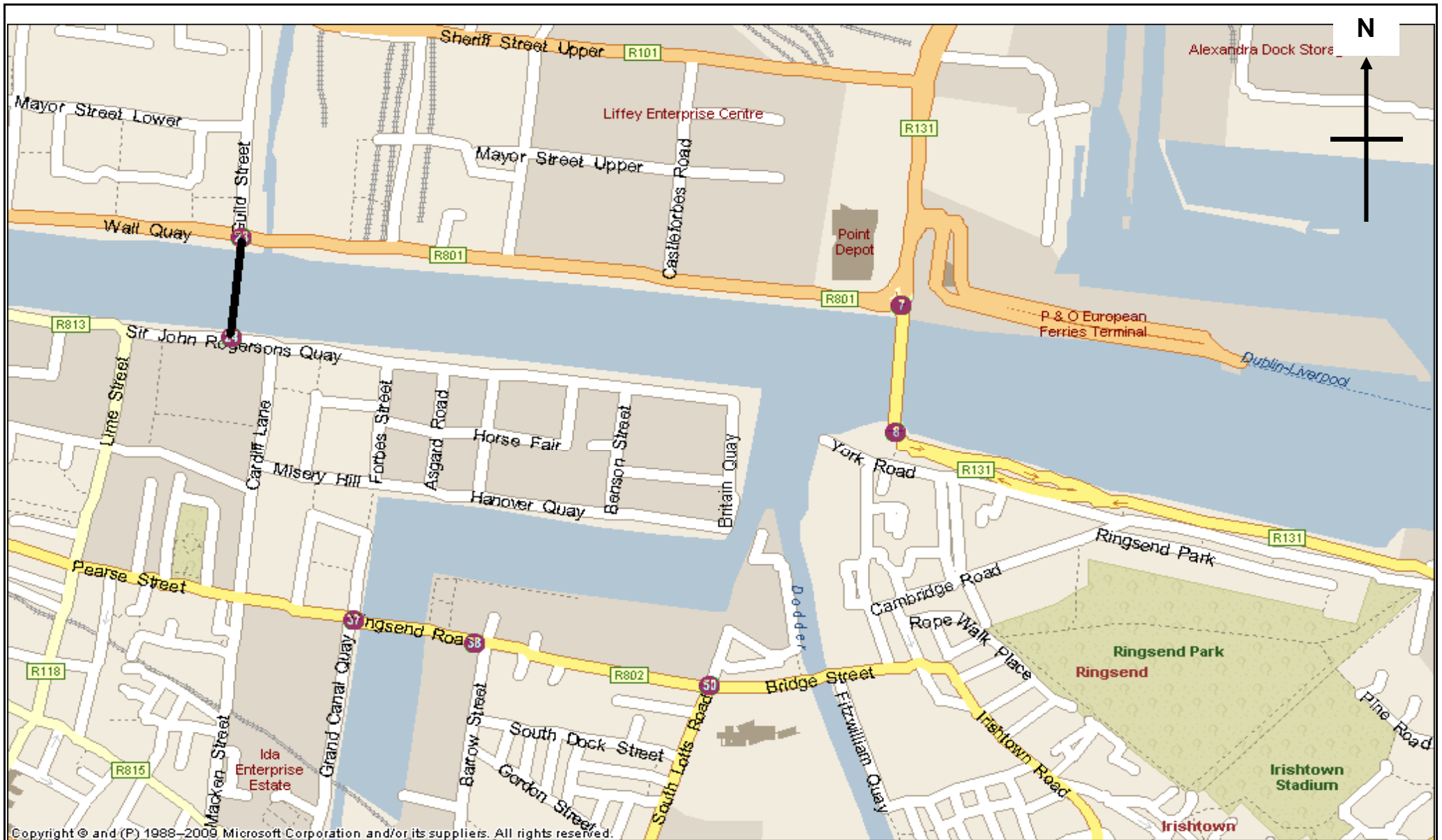

| | | | | | | | |
|--------------------------|--|-----------------------|-----------------------|--------------------|---------|------------------|----|
| Sites / Location: | 3, 4, 9 to 14, 39 to 42 & 44 to 46, 61 & 62 | Project No: | 5103 | Diagram No: | 5103-02 | Drawn By: | AC |
| Survey Date: | Sites 3,4,11 to 14, 61 & 62: Thursday 7th May 2015 Site 9,10,41,42 & 45: Tuesday 12th May 2015 Sites 39, 40 & 46: Wednesday 6th May 2015 Site 44: Wednesday 13th May 2015 | Project Name: | DCC COUNTS 2015 | | | | |
| Survey Times: | 07:00 to 19:00 | Diagram Title: | General Location Plan | | | | |

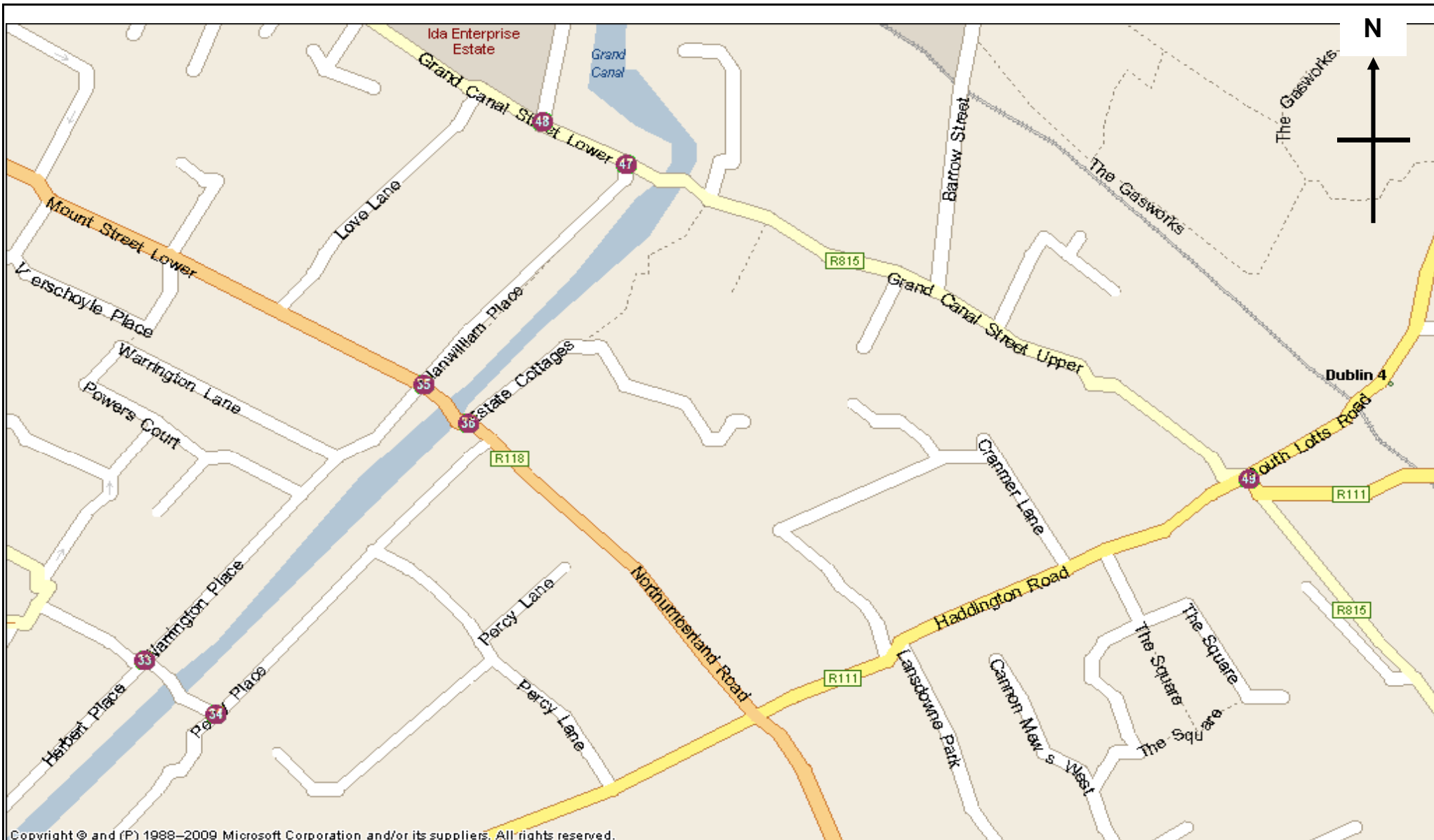

© copyright © and (P) 1988–2009 Microsoft Corporation and/or its suppliers. All rights reserved.

| | | | | | | | | |
|---|--------------------------|---|--------------------|-----------------------|-----------------------|---------|------------------|----|
|  | Sites / Location: | 7, 8, 23, 24, 37, 38 & 50 | Project No: | 5103 | Diagram No: | 5103-03 | Drawn By: | AC |
| | Survey Date: | Site 7, 8, 23, 24, 37 & 38: Wednesday 6th May 2015 Site 50: Tuesday 5th May 2015 | | Project Name: | DCC COUNTS 2015 | | | |
| | Survey Times: | 07:00 to 19:00 | | Diagram Title: | General Location Plan | | | |



| | | | | | | | | |
|---|--------------------------|----------------------|-----------------------|-----------------------|--------------------|---------|------------------|----|
|  | Sites / Location: | 33 to 36 & 47 to 49 | Project No: | 5103 | Diagram No: | 5103-04 | Drawn By: | AC |
| | Survey Date: | Tuesday 5th May 2015 | Project Name: | DCC COUNTS 2015 | | | | |
| | Survey Times: | 07:00 to 19:00 | Diagram Title: | General Location Plan | | | | |

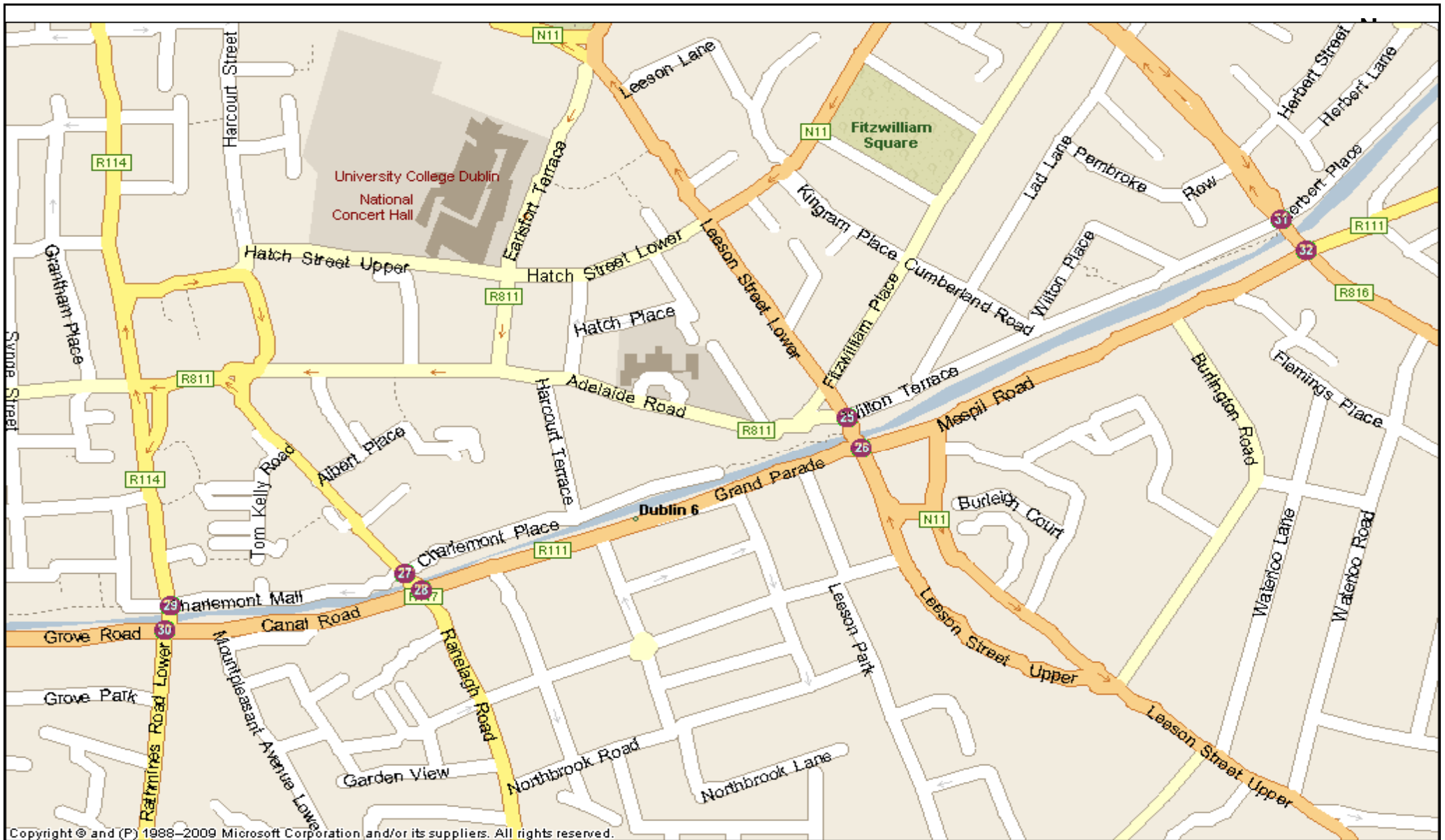

| | | | | | |
|---|---|---|----------------------------|---------------------|--|
|  | Sites / Location: 25 to 32 | Project No: 5103 | Diagram No: 5103-05 | Drawn By: AC | |
| | Survey Date: Sites 25 to 30: Thursday 7th May 2015 Site 31 & 32: Tuesday 5th May 2015 | Project Name: DCC COUNTS 2015 | | | |
| | Survey Times: 07:00 to 19:00 | Diagram Title: General Location Plan | | | |

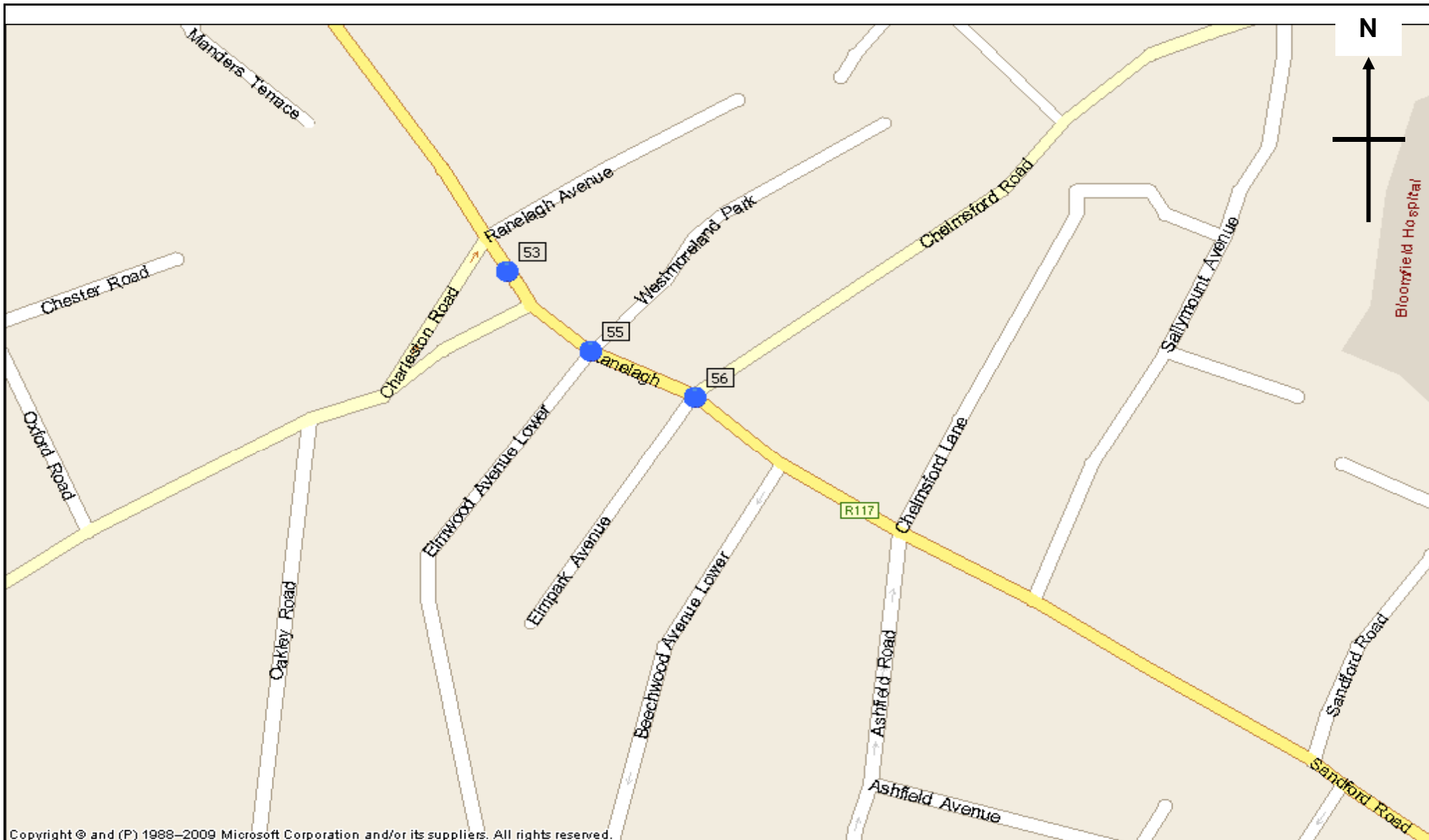

| | | | | | | | | |
|---|--------------------------|-----------------------|-----------------------|------|-----------------------|---------|------------------|----|
|  | Sites / Location: | 53, 55 & 56 | Project No: | 5103 | Diagram No: | 5103-06 | Drawn By: | AC |
| | Survey Date: | Thursday 7th May 2015 | Project Name: | | DCC COUNTS 2015 | | | |
| | Survey Times: | 07:00 to 19:00 | Diagram Title: | | General Location Plan | | | |

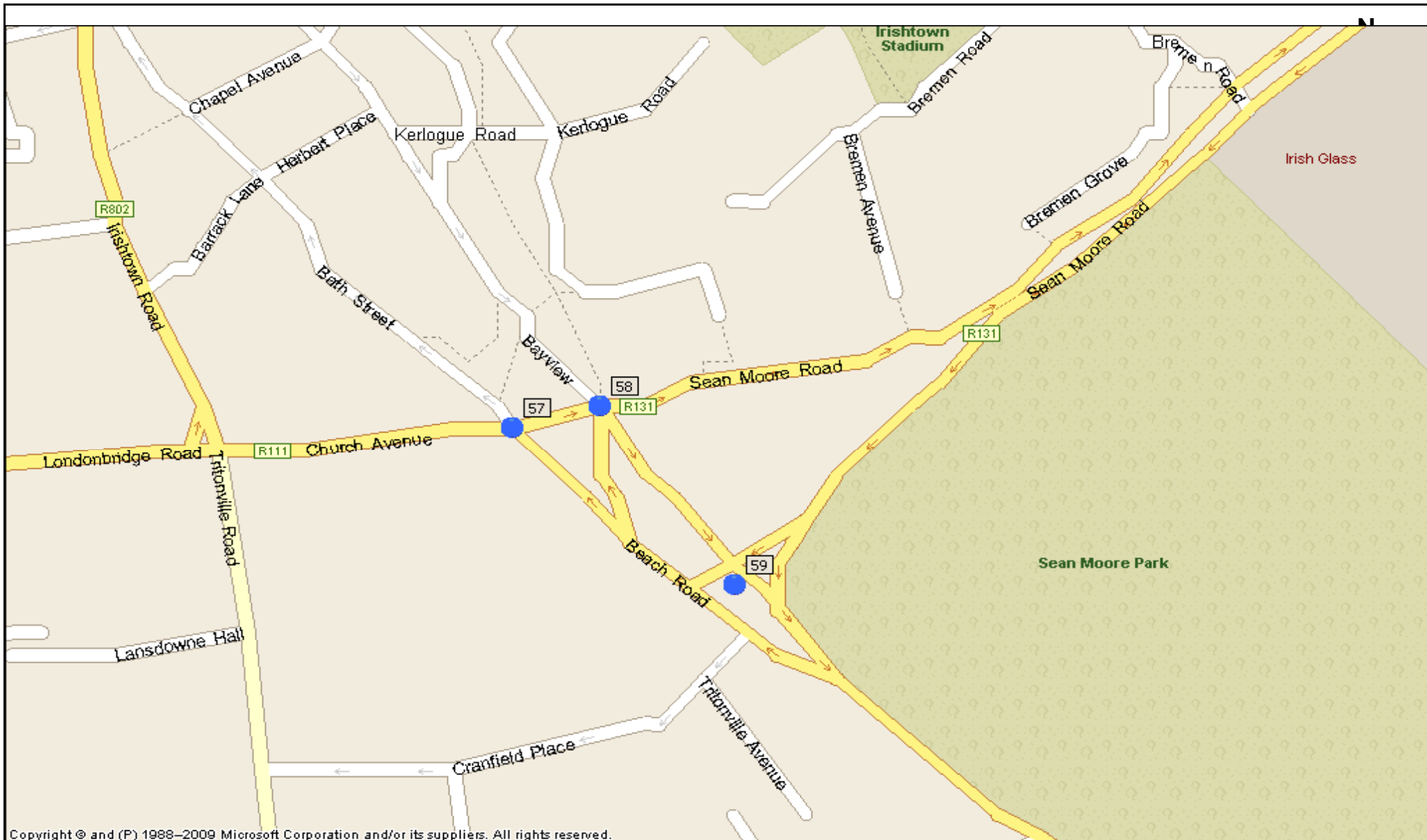

| | | | | |
|---|--|---|----------------------------|---------------------|
|  | Sites / Location: 57 to 59 | Project No: 5103 | Diagram No: 5103-07 | Drawn By: AC |
| | Survey Date: Wednesday 6th May 2015 | Project Name: DCC COUNTS 2015 | | |
| | Survey Times: 07:00 to 19:00 | Diagram Title: General Location Plan | | |

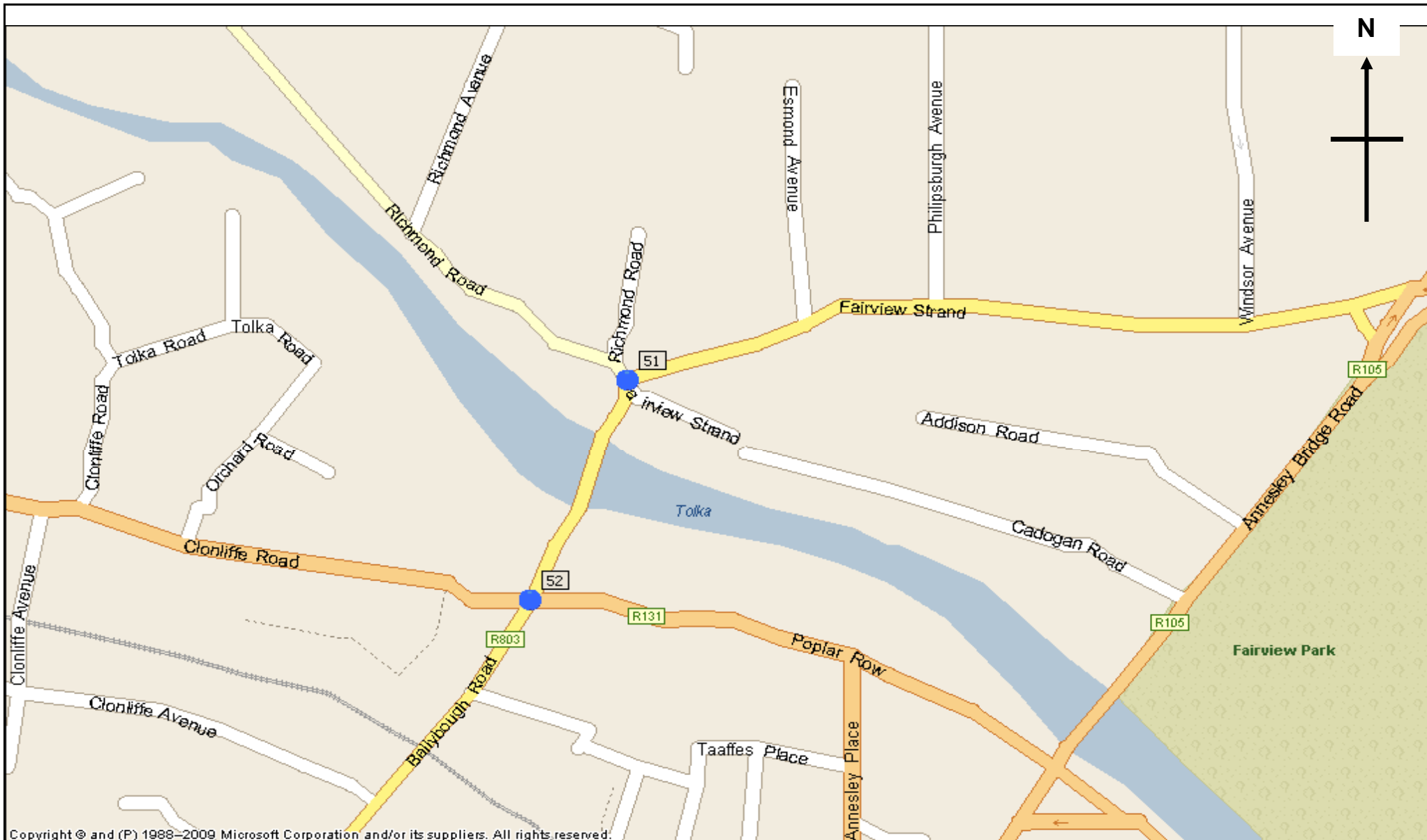

| | | | | | | | | |
|---|--------------------------|-----------------------|-----------------------|------|-----------------------|---------|------------------|----|
|  | Sites / Location: | 51 & 52 | Project No: | 5103 | Diagram No: | 5103-08 | Drawn By: | AC |
| | Survey Date: | Thursday 7th May 2015 | Project Name: | | DCC COUNTS 2015 | | | |
| | Survey Times: | 07:00 to 19:00 | Diagram Title: | | General Location Plan | | | |

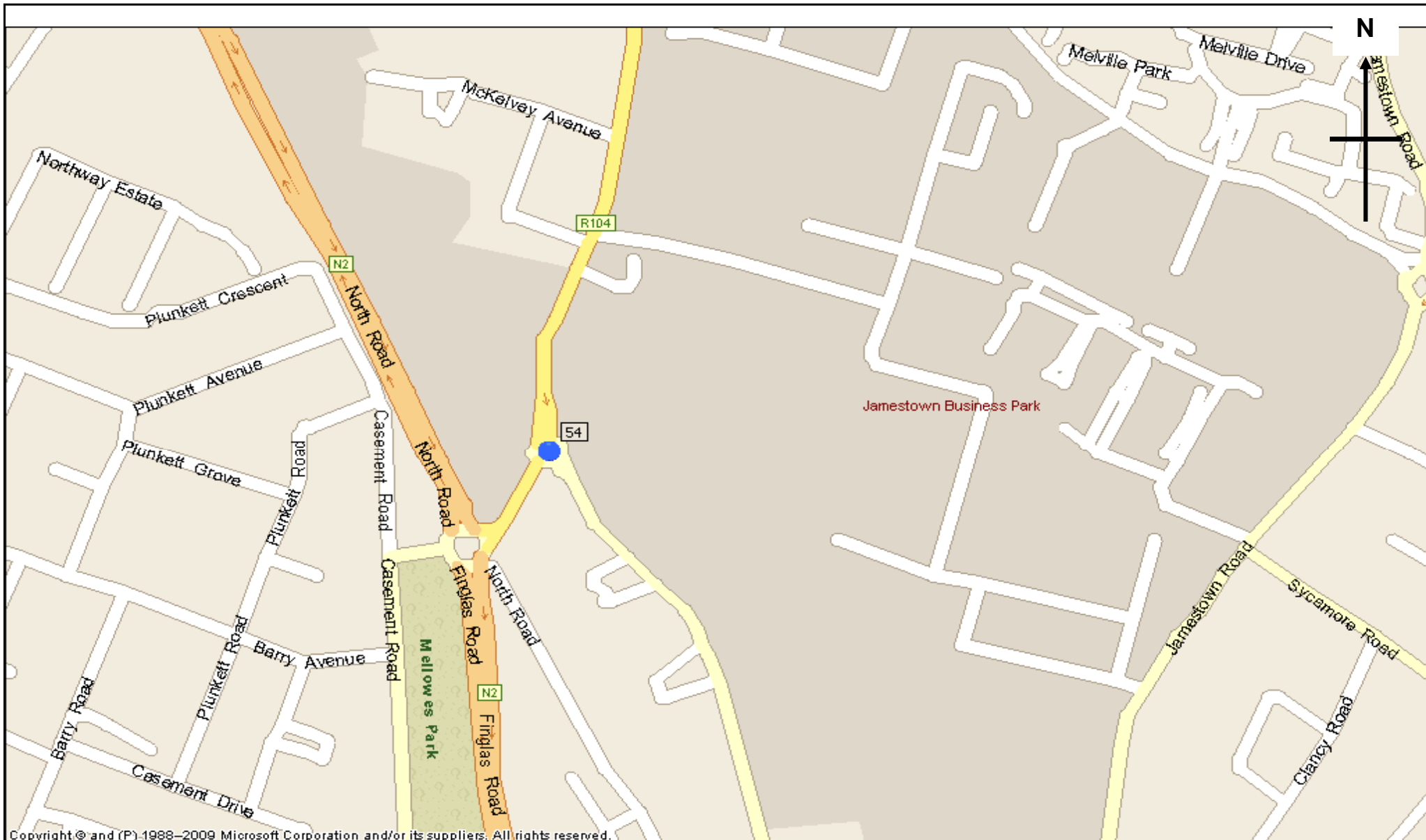

Copyright © and (P) 1988–2009 Microsoft Corporation and/or its suppliers. All rights reserved.

| | | | | |
|---|---|---|-----------------------------|---------------------|
|  | Site / Location: 54 | Project No.: 5103 | Diagram No.: 5103-09 | Drawn By: AC |
| | Survey Date: Tuesday 12th May 2015 | Project Name: DCC COUNTS 2015 | | |
| | Survey Times: 07:00 to 19:00 | Diagram Title: General Location Plan | | |

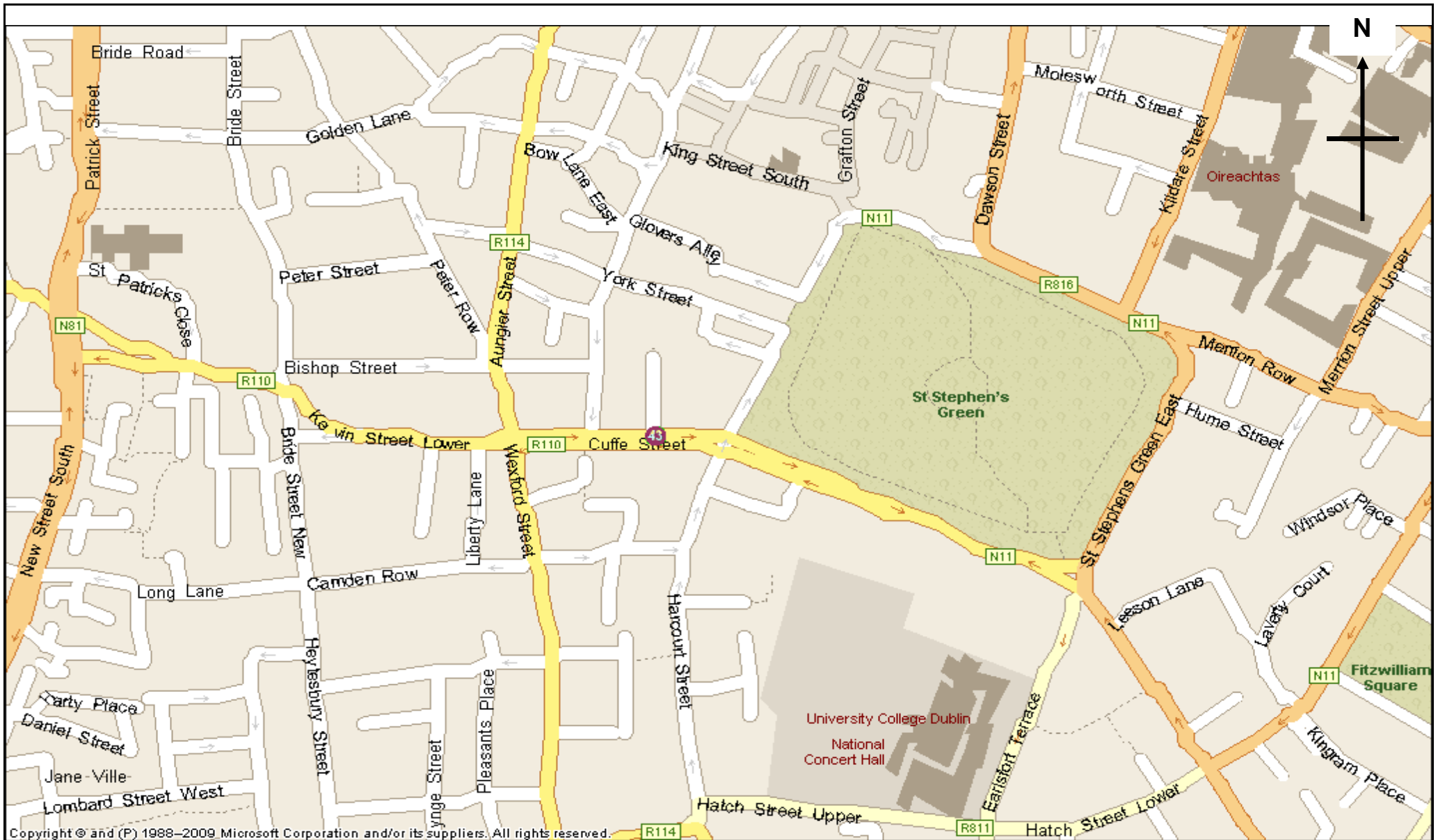

Copyright © and (P) 1988–2009 Microsoft Corporation and/or its suppliers. All rights reserved.

| | | | | | | | | |
|---|-------------------------|-----------------------|-----------------------|-----------------------|---------------------|---------|------------------|----|
|  | Site / Location: | 43 | Project No.: | 5103 | Diagram No.: | 5103-10 | Drawn By: | AC |
| | Survey Date: | Tuesday 12th May 2015 | Project Name: | DCC COUNTS 2015 | | | | |
| | Survey Times: | 07:00 to 19:00 | Diagram Title: | General Location Plan | | | | |

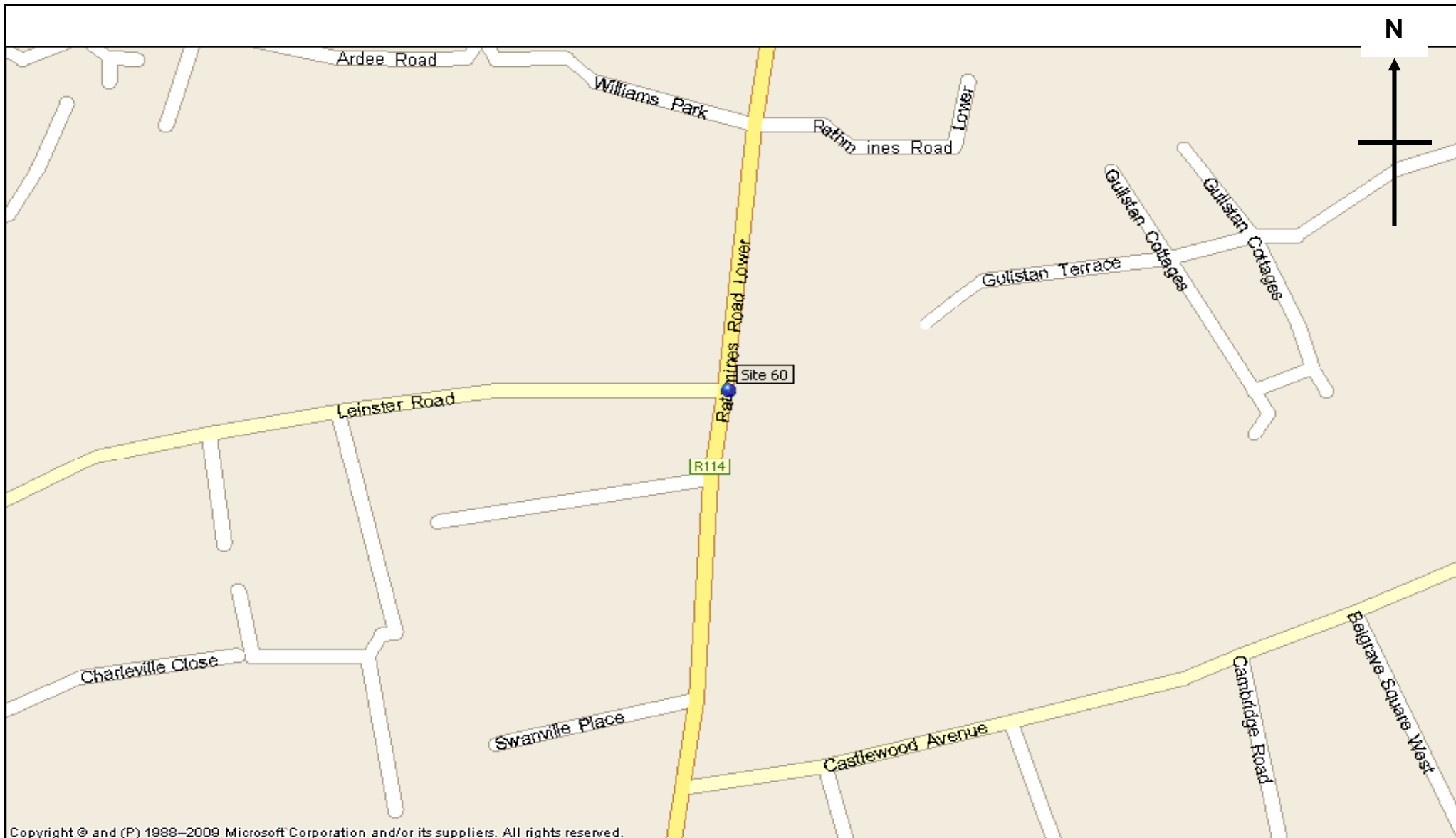

| | | | | |
|---|---|---|----------------------------|---------------------|
|  | Site / Location: 60 | Project No: 5103 | Diagram No: 5103-11 | Drawn By: AC |
| | Survey Date: Thursday 7th May 2015 | Project Name: DCC COUNTS 2015 | | |
| | Survey Times: 07:00 to 19:00 | Diagram Title: General Location Plan | | |

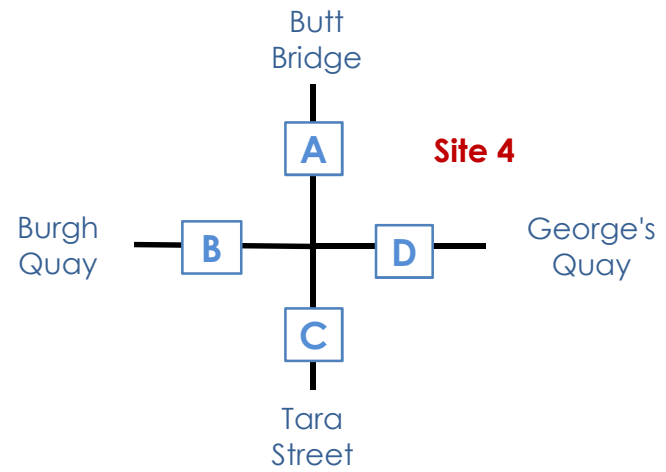
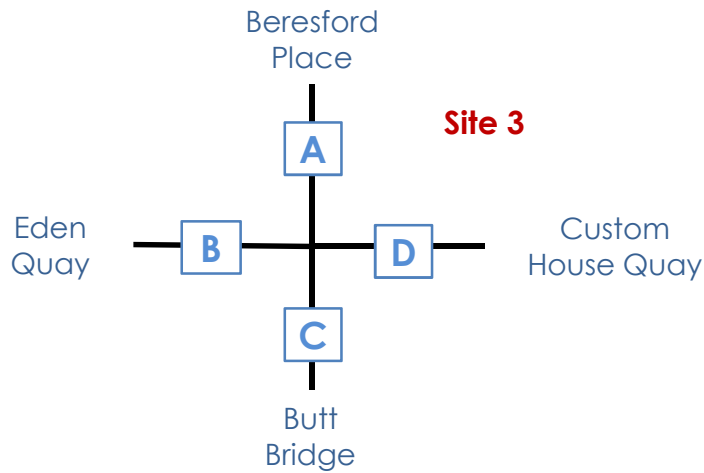
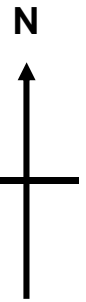
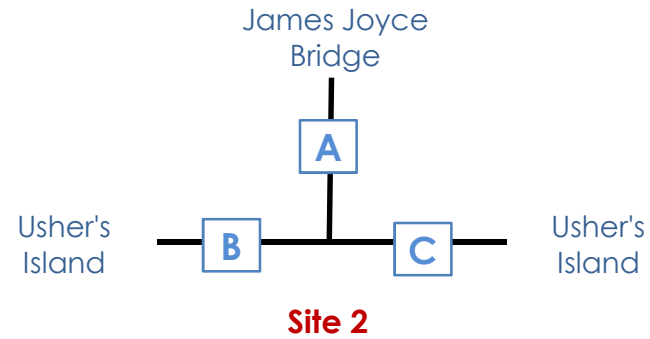
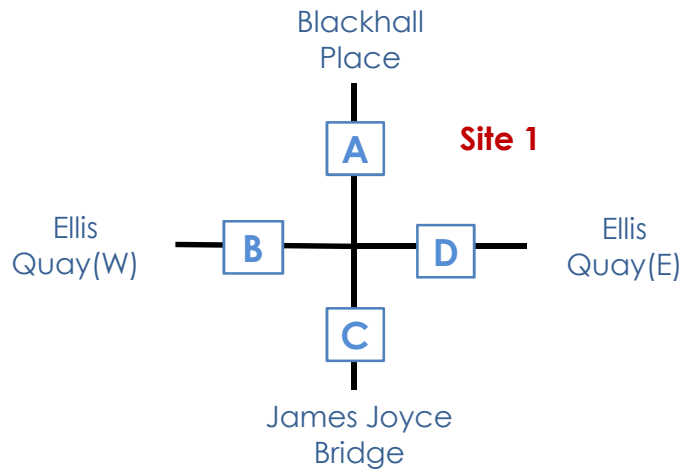

| | | | | | | | |
|--------------------------|----------------------|--------------------|--|------------------------------------|----------------------|------------------|-----------------|
| Sites / Location: | 1 to 4 / Dublin | Project No: | 5103 | Drawing No: | 5103-01 | Drawn By: | AC |
| | Survey Date: | | Sites 1 & 2: Wednesday 13th May 2015 Sites 3 & 4: Thursday 7th May 2015 | | Project Name: | | DCC COUNTS 2015 |
| | Survey Times: | 07:00 to 19:00 | Drawing Title: | Site Layout and Observed Movements | | | |

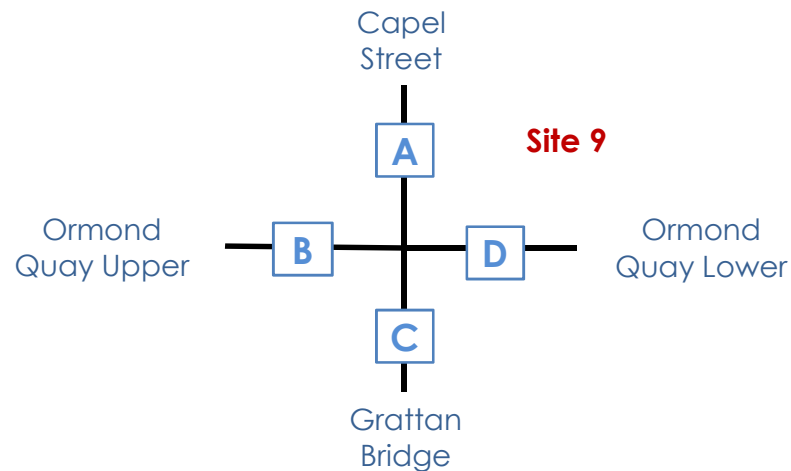
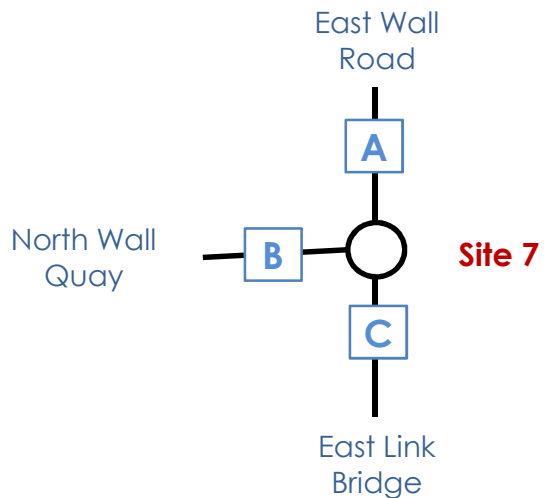
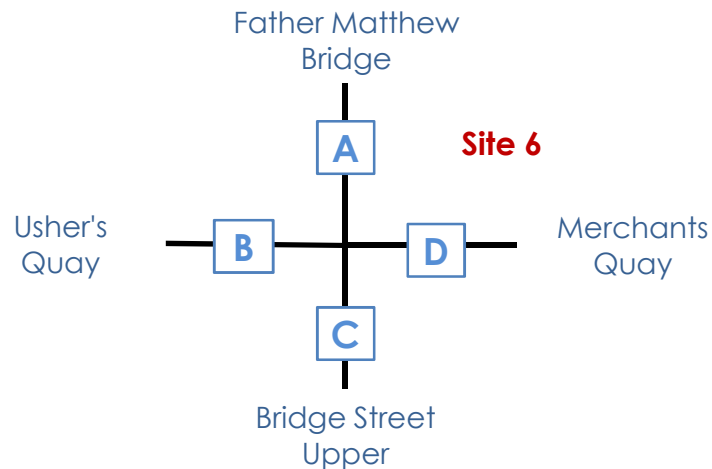
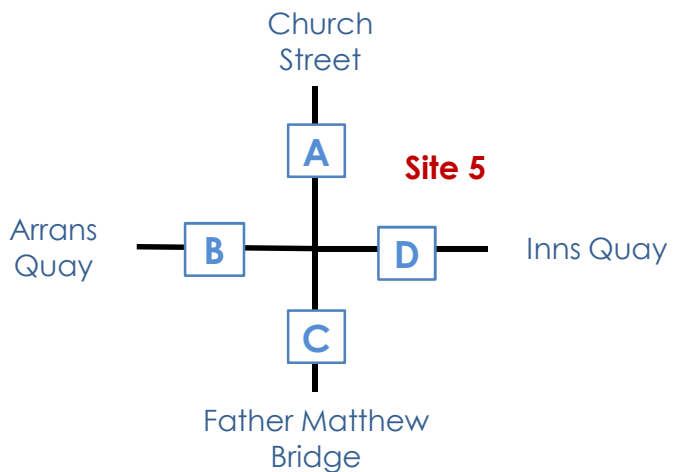
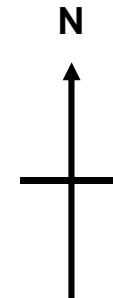

| | | | | | | | | | |
|--------------------------|----------------------|--------------------|--|--------------------|----------------------|------------------|-----------------------|------------------------------------|--|
| Sites / Location: | 5 to 7 & 9 / Dublin | Project No: | 5103 | Drawing No: | 5103-02 | Drawn By: | AC | | |
| | Survey Date: | | Site 5, 6 & 9: Tuesday 12th May 2015 Site 7: Wednesday 6th May 2015 | | Project Name: | | DCC COUNTS 2015 | | |
| | Survey Times: | | 07:00 to 19:00 | | | | Drawing Title: | Site Layout and Observed Movements | |

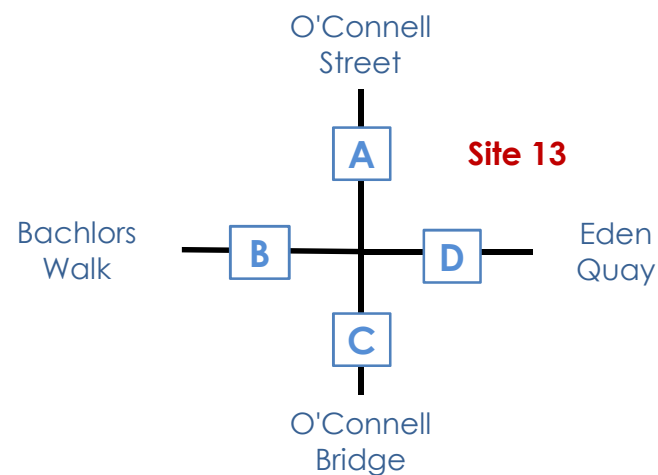
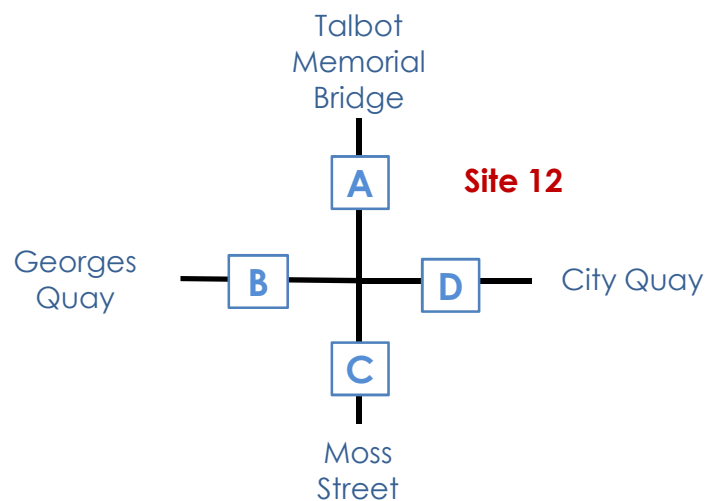
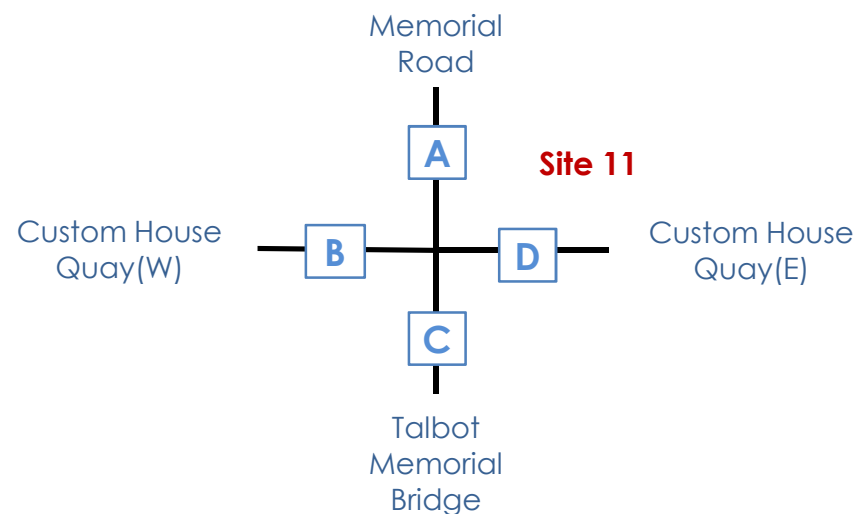
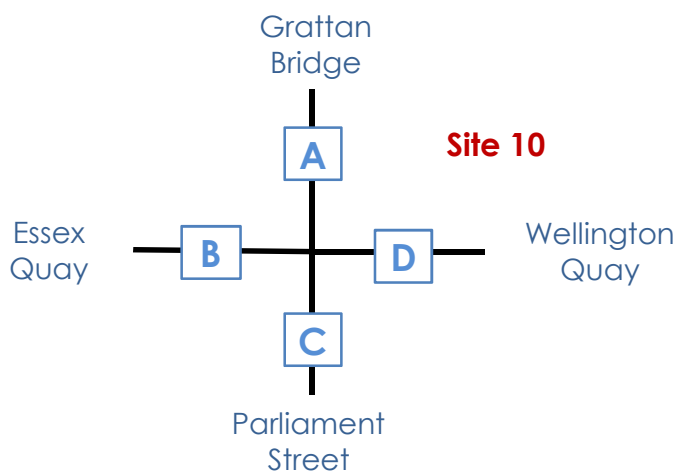
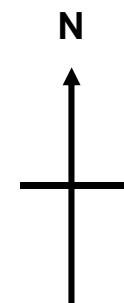

| | | | | | | | | | | |
|--------------------------|----------------------|--------------------|--|--------------------|----------------------|------------------|-----------------------|------------------------------------|--|--|
| Sites / Location: | 10 to 13 / Dublin | Project No: | 5103 | Drawing No: | 5103-03 | Drawn By: | AC | | | |
| | Survey Date: | | Site 10: Tuesday 12th May 2015 Site 11 to 13: Thursday 7th May 2015 | | Project Name: | | DCC COUNTS 2015 | | | |
| | Survey Times: | | 07:00 to 19:00 | | | | Drawing Title: | Site Layout and Observed Movements | | |

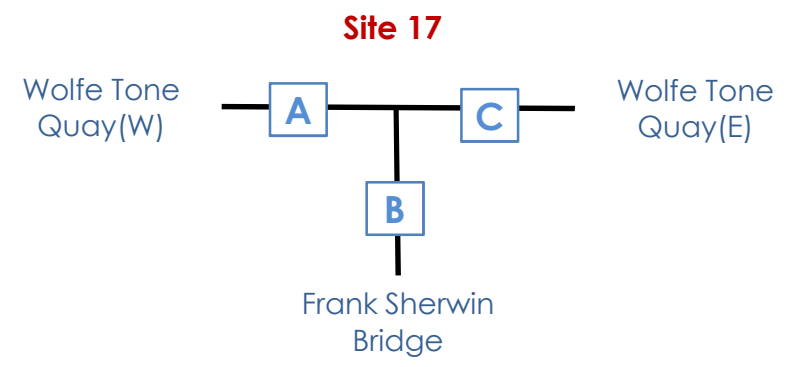
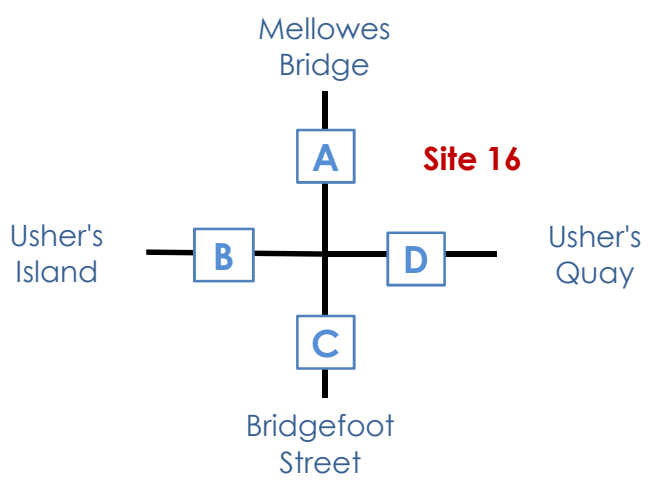
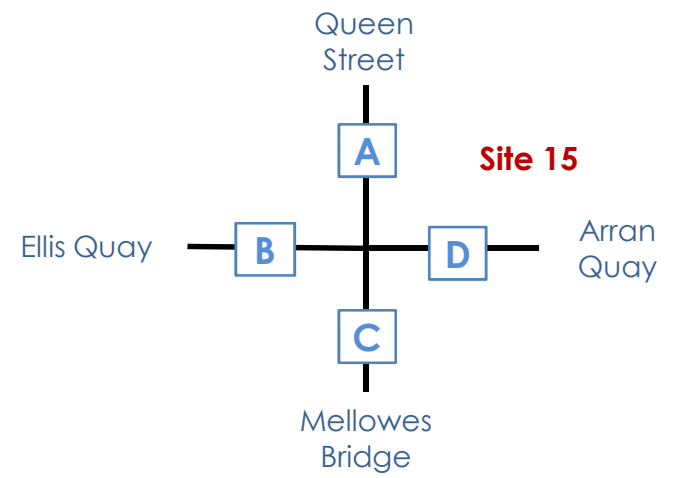
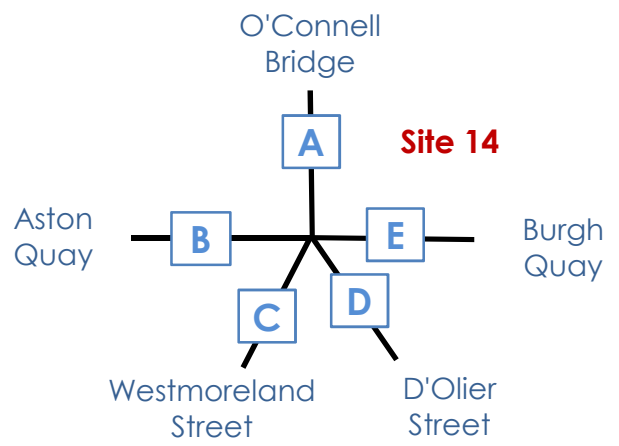
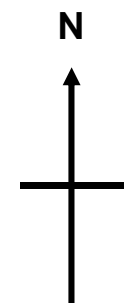

| | | | | | | | | | |
|--------------------------|----------------------|--------------------|---|--------------------|----------------------|------------------|-----------------------|------------------------------------|--|
| Sites / Location: | 14 to 17 / Dublin | Project No: | 5103 | Drawing No: | 5103-04 | Drawn By: | AC | | |
| | Survey Date: | | Site 14: Thursday 7th May 2015 Sites 15 to 17: Wednesday 13th May 2015 | | Project Name: | | DCC COUNTS 2015 | | |
| | Survey Times: | | 07:00 to 19:00 | | | | Drawing Title: | Site Layout and Observed Movements | |

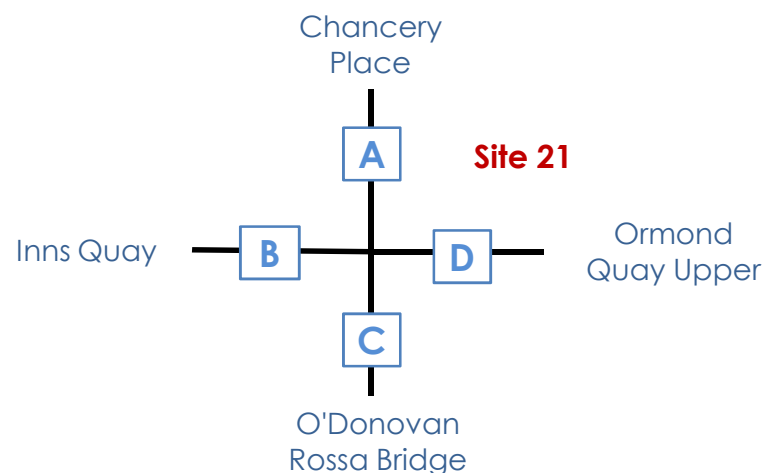
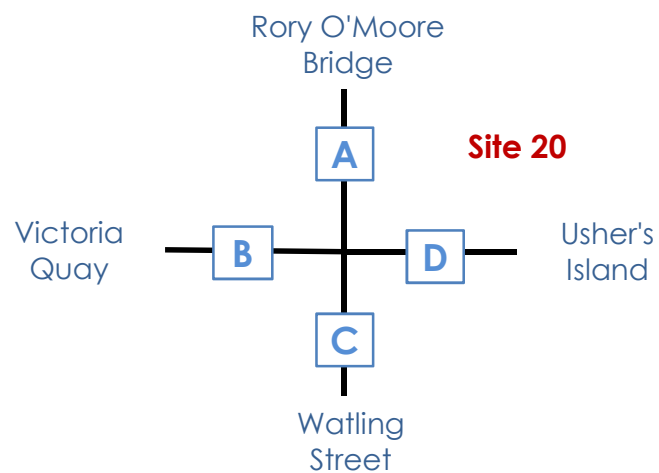
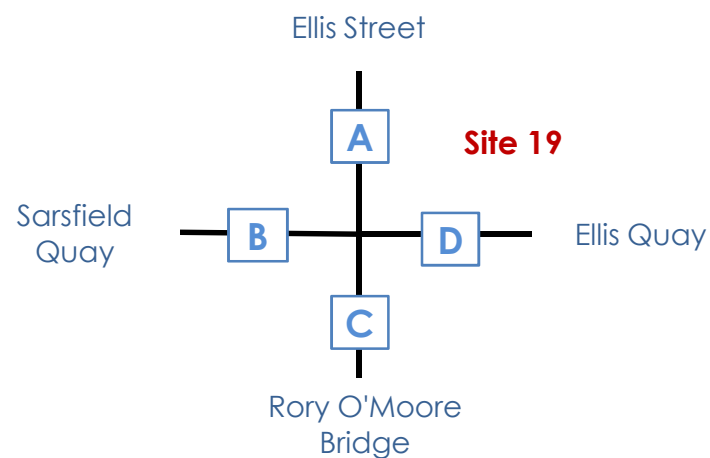
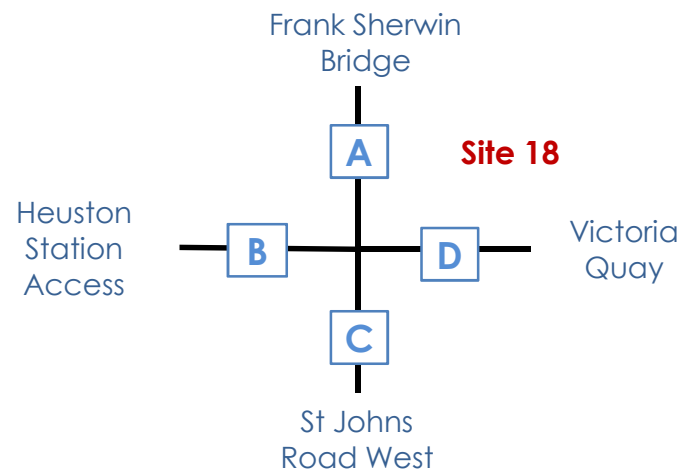
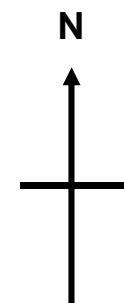

| | | | | | | | |
|--------------------------|----------------------|--------------------|---|------------------------------------|----------------------|------------------|-----------------|
| Sites / Location: | 18 to 21 / Dublin | Project No: | 5103 | Drawing No: | 5103-05 | Drawn By: | AC |
| | Survey Date: | | Sites 18 to 20: Wednesday 13th May 2015 Site 21: Tuesday 12th May 2015 | | Project Name: | | DCC COUNTS 2015 |
| | Survey Times: | 07:00 to 19:00 | Drawing Title: | Site Layout and Observed Movements | | | |

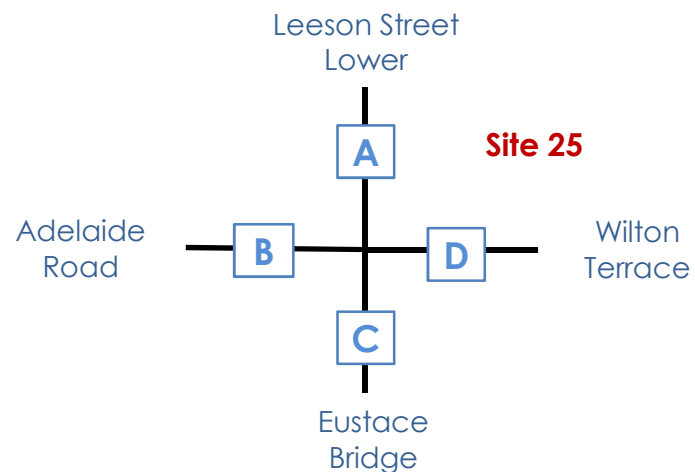
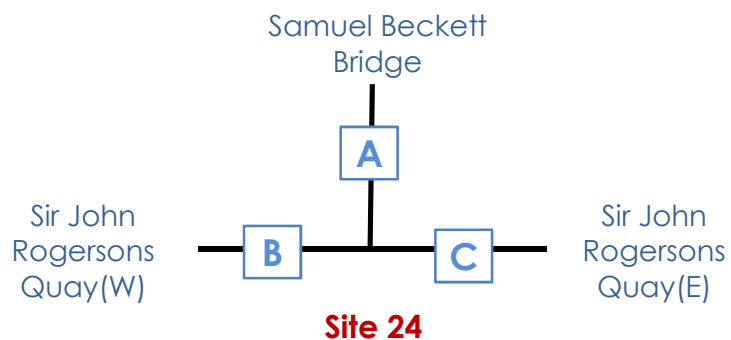
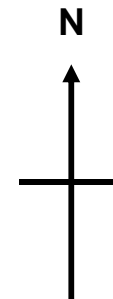
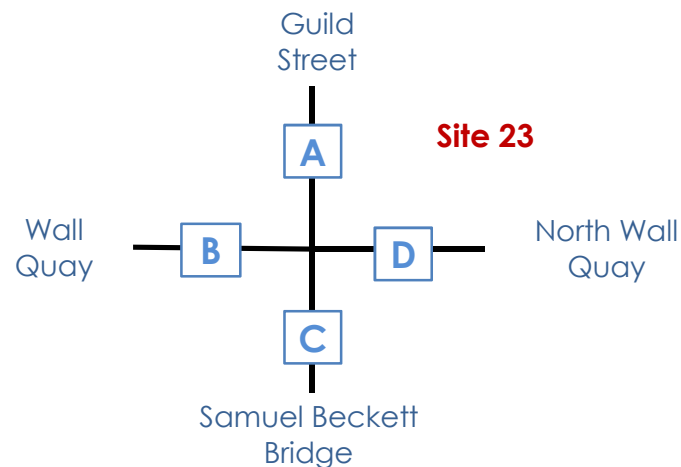
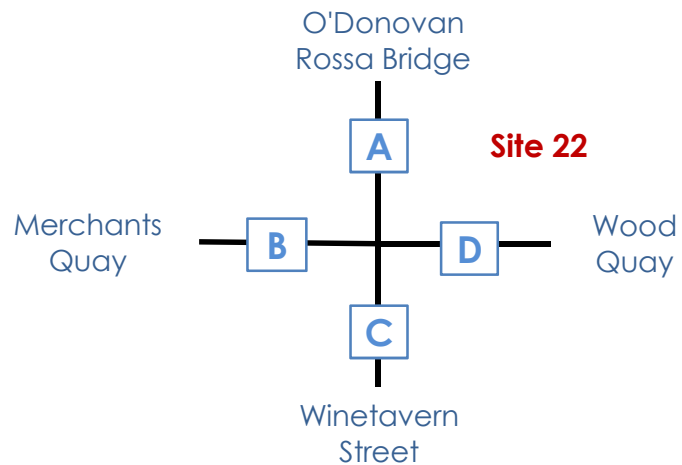

| | | | | | | | |
|--------------------------|----------------------|--------------------|---|------------------------------------|----------------------|------------------|-----------------|
| Sites / Location: | 22 to 25 / Dublin | Project No: | 5103 | Drawing No: | 5103-06 | Drawn By: | AC |
| | Survey Date: | | Site 22: Tuesday 12th May 2015 Sites 23 & 24: Wednesday 6th May 2015 Site 25: Thursday 7th May 2015 | | Project Name: | | DCC COUNTS 2015 |
| | Survey Times: | 07:00 to 19:00 | Drawing Title: | Site Layout and Observed Movements | | | |

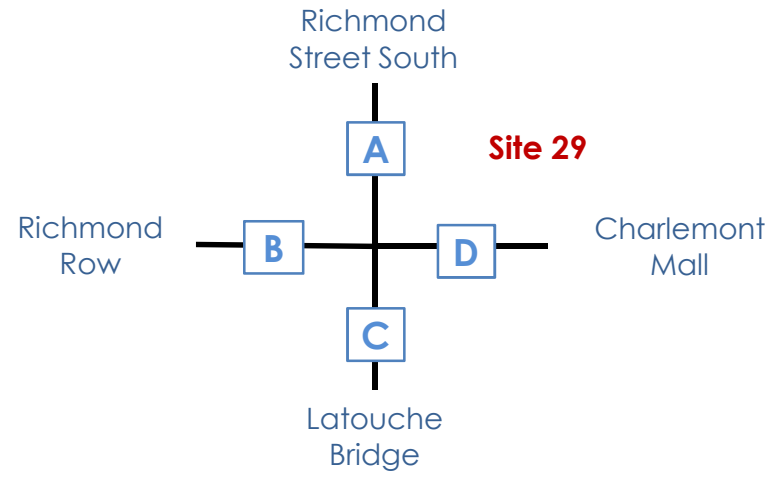
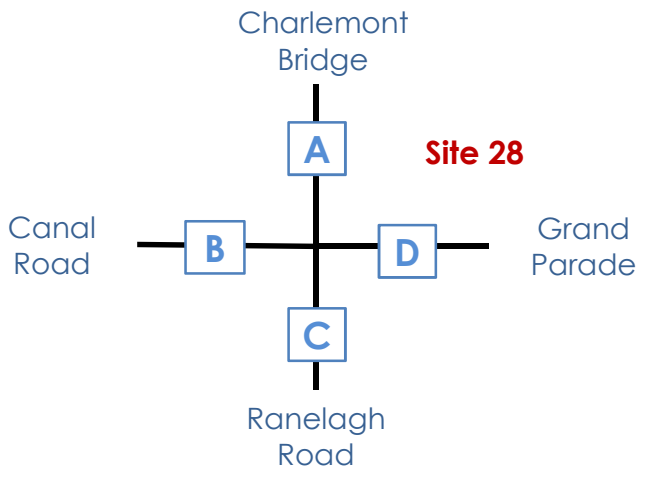
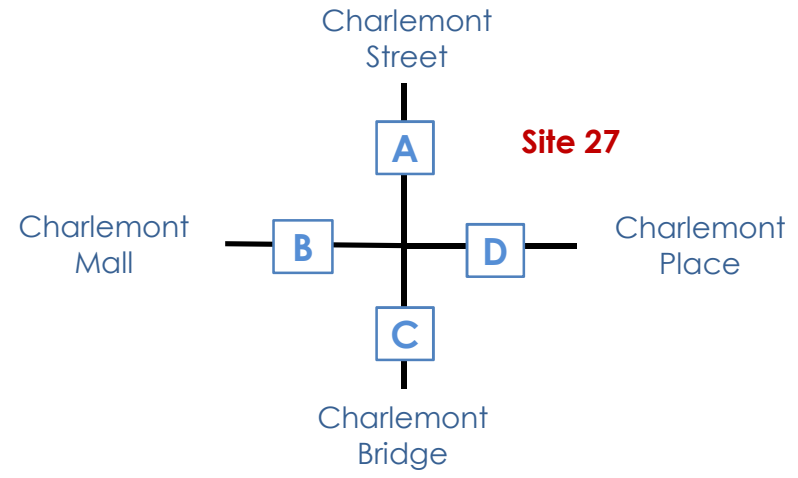
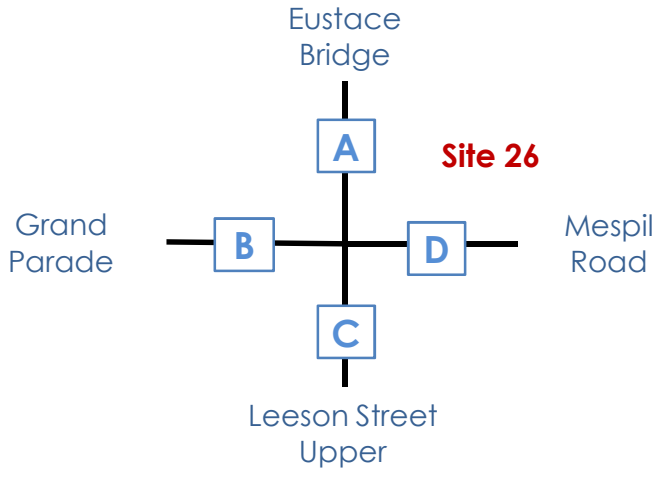
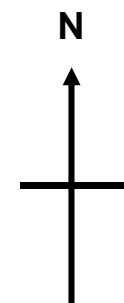

| | | | | | | | | |
|---|--------------------------|-----------------------|-----------------------|------|------------------------------------|---------|------------------|----|
|  | Sites / Location: | 26 to 29 / Dublin | Project No: | 5103 | Drawing No: | 5103-07 | Drawn By: | AC |
| | Survey Date: | Thursday 7th May 2015 | Project Name: | | DCC COUNTS 2015 | | | |
| | Survey Times: | 07:00 to 19:00 | Drawing Title: | | Site Layout and Observed Movements | | | |

N

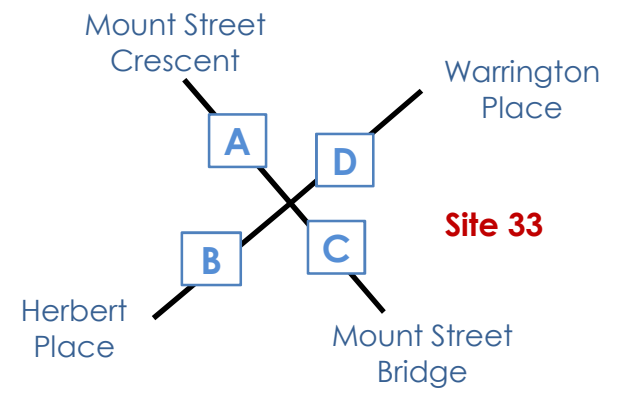
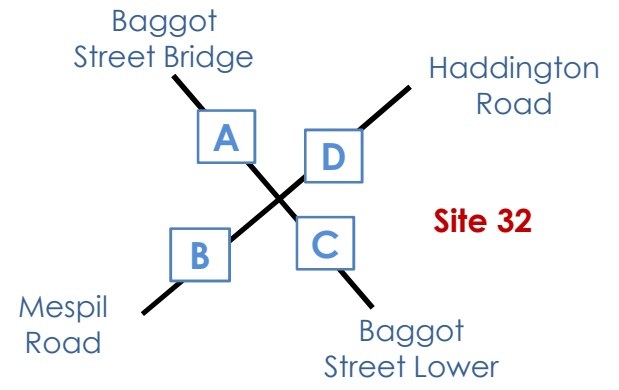
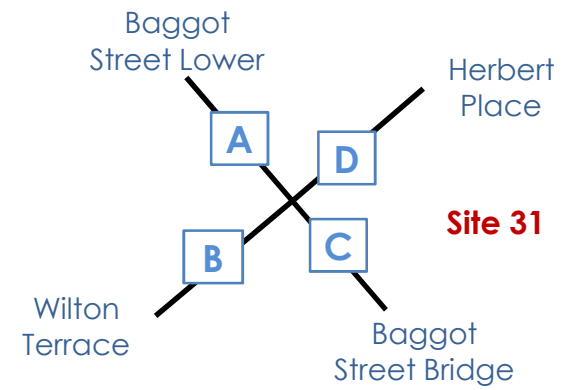
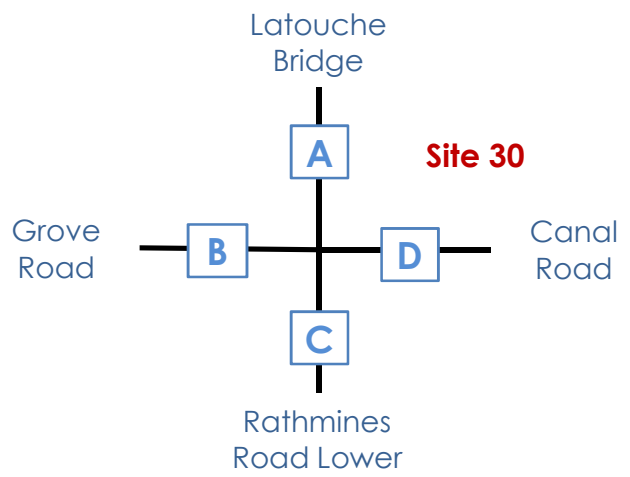
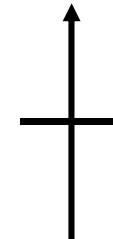

| | | | | | | | | | | |
|--------------------------|----------------------|--------------------|--|--------------------|----------------------|------------------|-----------------------|------------------------------------|--|--|
| Sites / Location: | 30 to 33 / Dublin | Project No: | 5103 | Drawing No: | 5103-08 | Drawn By: | AC | | | |
| | Survey Date: | | Site 30: Thursday 7th May 2015 Sites 31 to 33: Tuesday 5th May 2015 | | Project Name: | | DCC COUNTS 2015 | | | |
| | Survey Times: | | 07:00 to 19:00 | | | | Drawing Title: | Site Layout and Observed Movements | | |

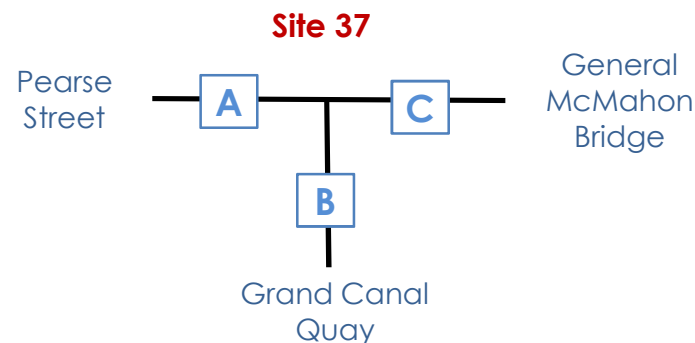
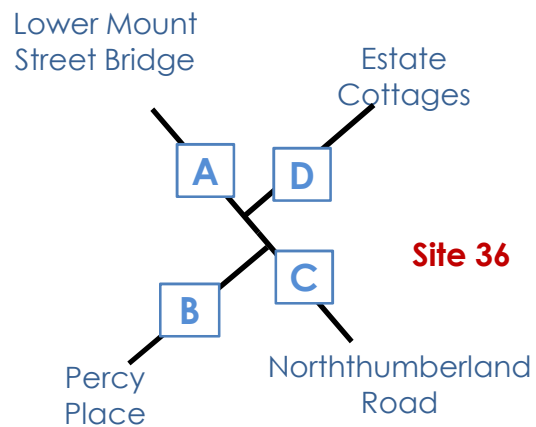
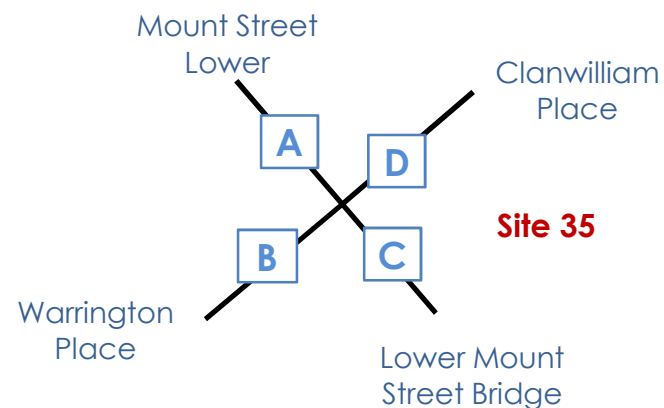
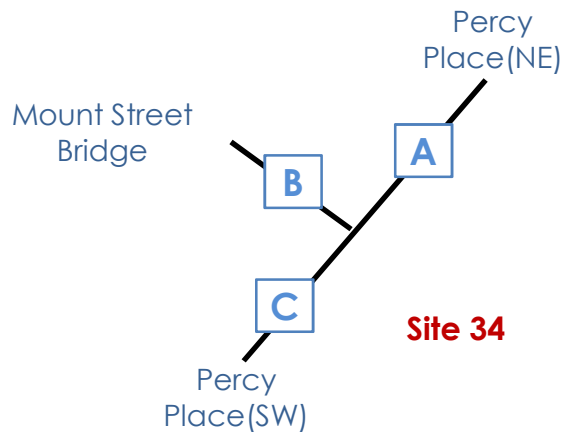
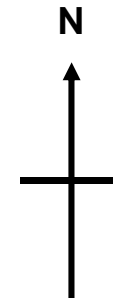

| | | | | | | | | | |
|--------------------------|----------------------|--------------------|---|--------------------|----------------------|------------------|-----------------------|------------------------------------|--|
| Sites / Location: | 34 to 37 / Dublin | Project No: | 5103 | Drawing No: | 5103-09 | Drawn By: | AC | | |
| | Survey Date: | | Sites 34 to 36: Tuesday 5th May 2015 Site 37: Wednesday 6th May 2015 | | Project Name: | | DCC COUNTS 2015 | | |
| | Survey Times: | | 07:00 to 19:00 | | | | Drawing Title: | Site Layout and Observed Movements | |

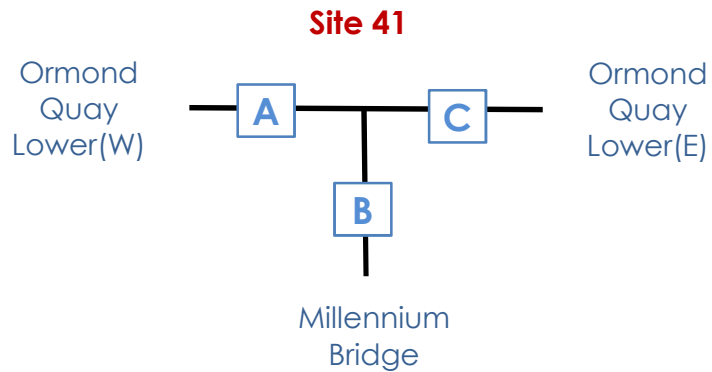
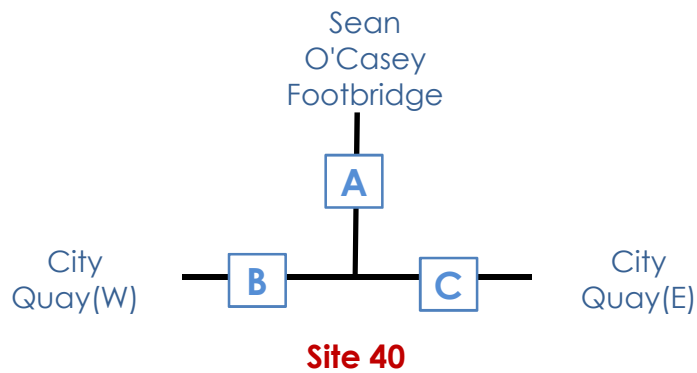
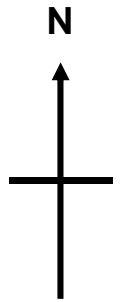
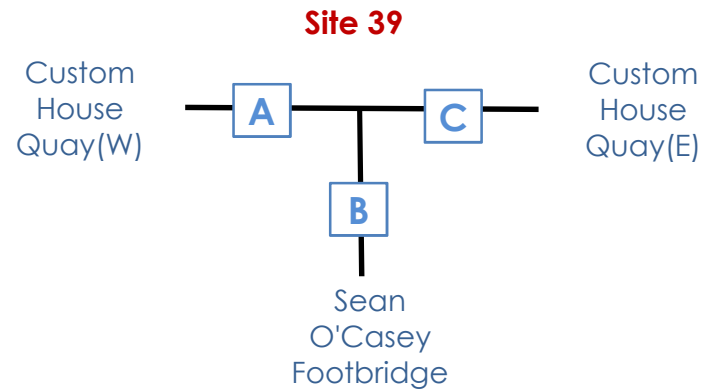
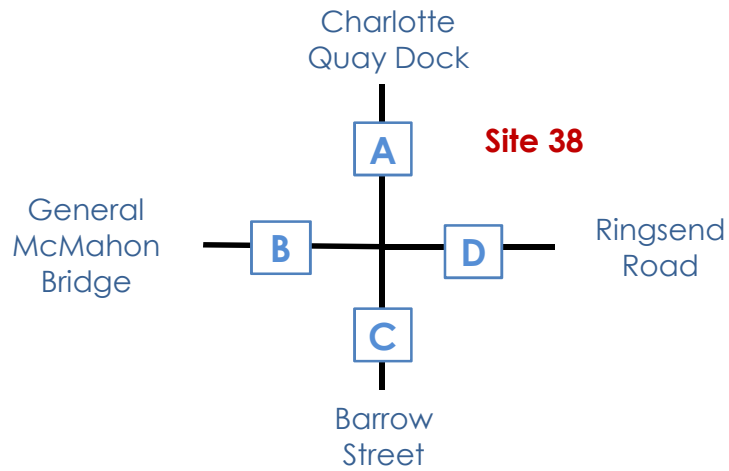

| | | | | | | | |
|--------------------------|----------------------|--------------------|--|------------------------------------|----------------------|------------------|-----------------|
| Sites / Location: | 38 to 41 / Dublin | Project No: | 5103 | Drawing No: | 5103-10 | Drawn By: | AC |
| | Survey Date: | | Sites 38 to 40: Wednesday 6th May 2015 Site 41: Tuesday 12th May 2015 | | Project Name: | | DCC COUNTS 2015 |
| | Survey Times: | 07:00 to 19:00 | Drawing Title: | Site Layout and Observed Movements | | | |

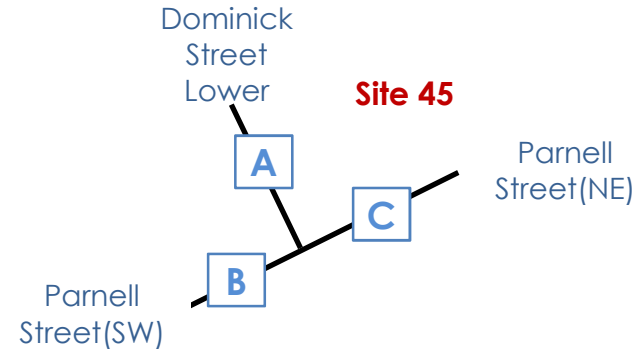
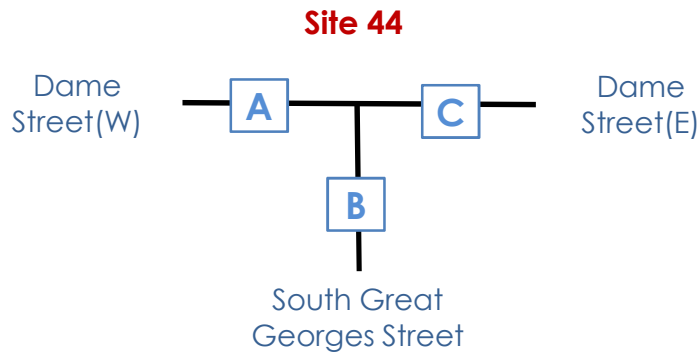
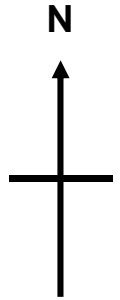
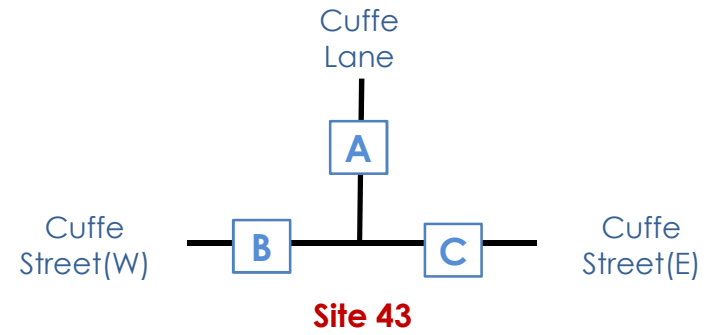
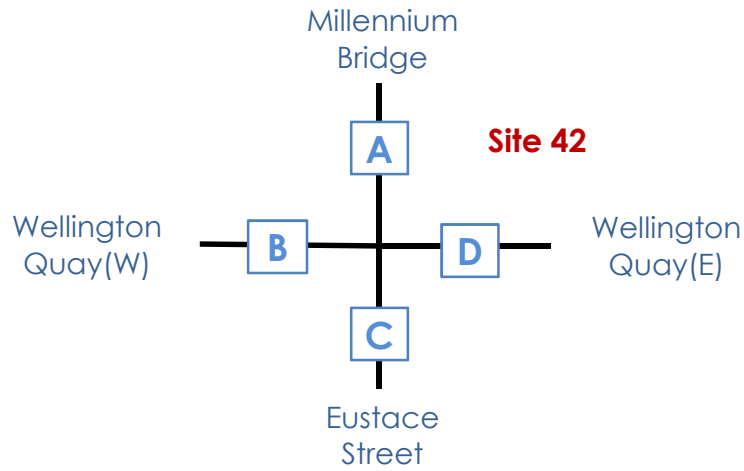

| | | | | | | | | | |
|--------------------------|----------------------|--------------------|---|--------------------|----------------------|------------------|-----------------------|------------------------------------|--|
| Sites / Location: | 42 to 45 / Dublin | Project No: | 5103 | Drawing No: | 5103-11 | Drawn By: | AC | | |
| | Survey Date: | | Site 42, 43 & 45: Tuesday 12th May 2015 Site 44: Wednesday 13th May 2015 | | Project Name: | | DCC COUNTS 2015 | | |
| | Survey Times: | | 07:00 to 19:00 | | | | Drawing Title: | Site Layout and Observed Movements | |

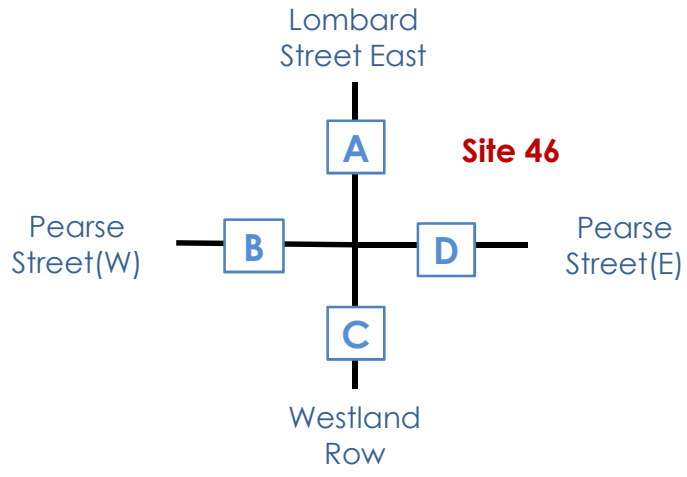

Site 46

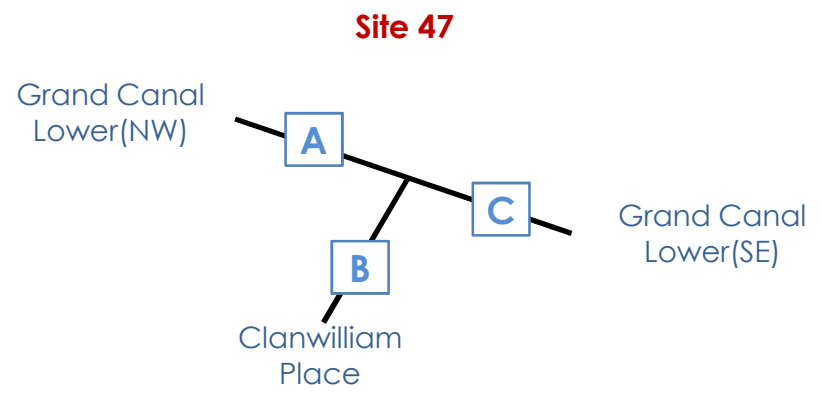

Site 47

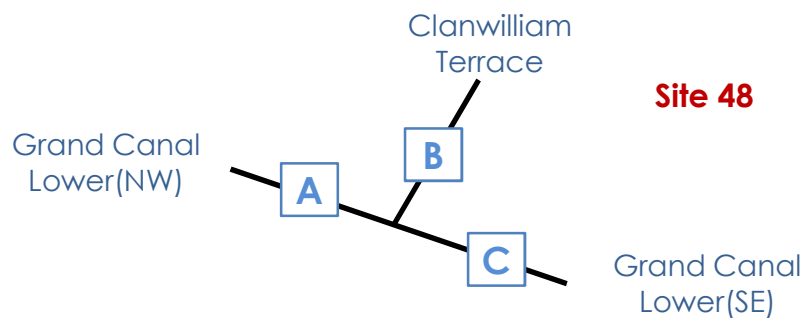
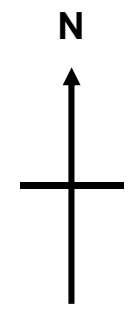

Site 48

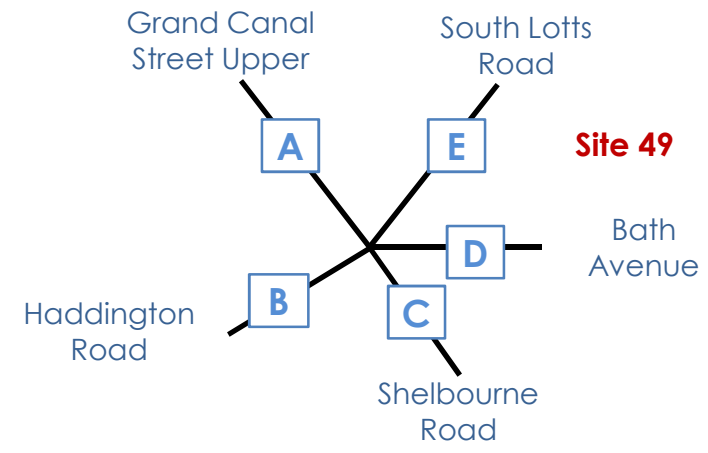

Site 49



| | | | | | | | | | | |
|--------------------------|----------------------|--------------------|---|--------------------|----------------------|------------------|-----------------------|------------------------------------|--|--|
| Sites / Location: | 46 to 49 / Dublin | Project No: | 5103 | Drawing No: | 5103-12 | Drawn By: | AC | | | |
| | Survey Date: | | Site 46: Wednesday 6th May 2015 Sites 47 to 49: Tuesday 5th May 2015 | | Project Name: | | DCC COUNTS 2015 | | | |
| | Survey Times: | | 07:00 to 19:00 | | | | Drawing Title: | Site Layout and Observed Movements | | |

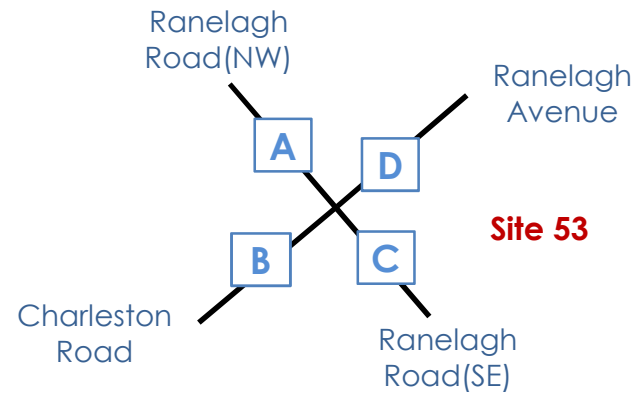
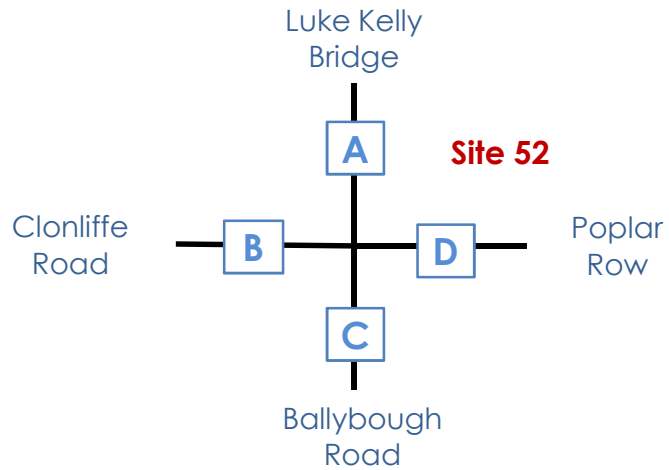
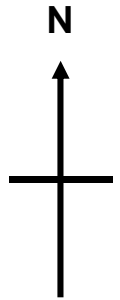
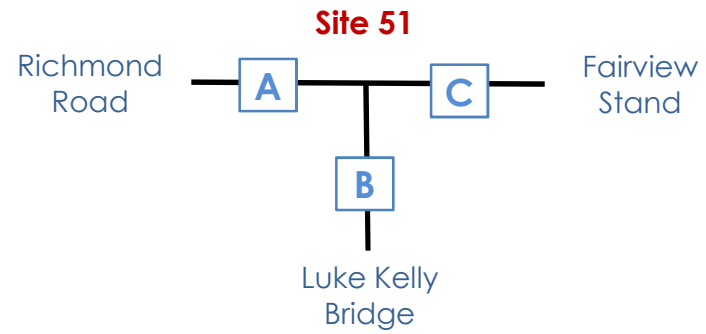
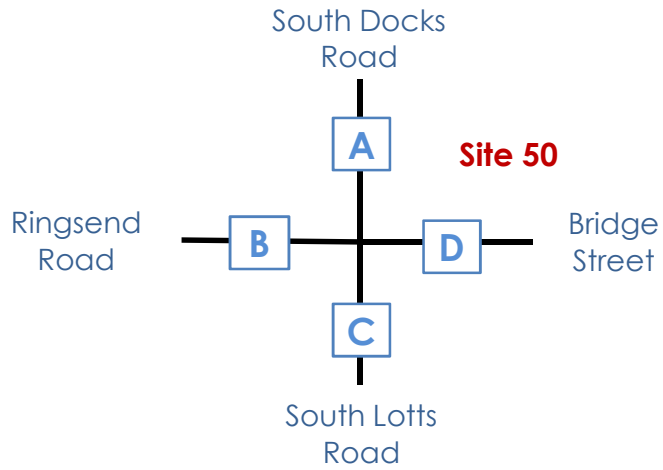

| | | | | | | | | | |
|--------------------------|----------------------|--------------------|--|--------------------|----------------------|------------------|-----------------------|------------------------------------|--|
| Sites / Location: | 50 to 53 / Dublin | Project No: | 5103 | Drawing No: | 5103-13 | Drawn By: | AC | | |
| | Survey Date: | | Site 50: Tuesday 5th May 2015 Sites 51 to 53: Thursday 7th May 2015 | | Project Name: | | DCC COUNTS 2015 | | |
| | Survey Times: | | 07:00 to 19:00 | | | | Drawing Title: | Site Layout and Observed Movements | |

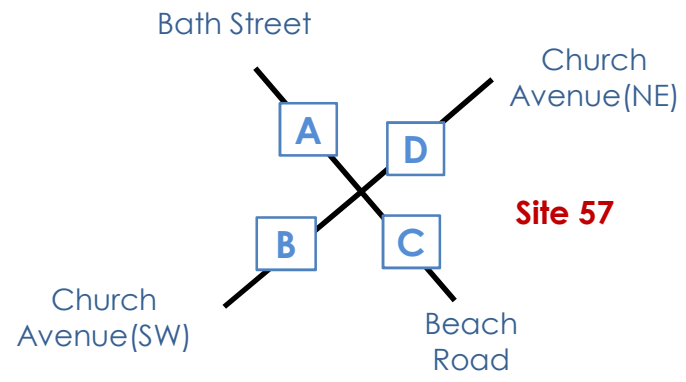
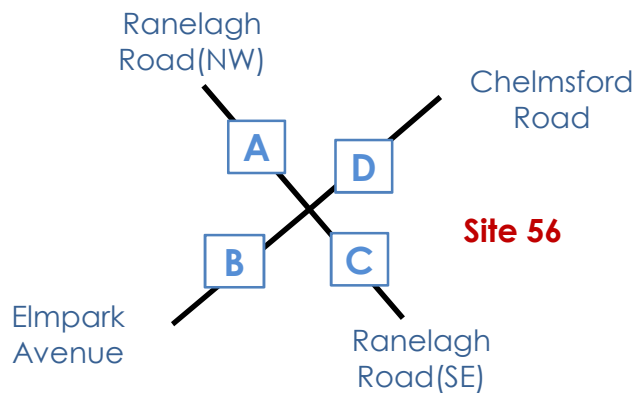
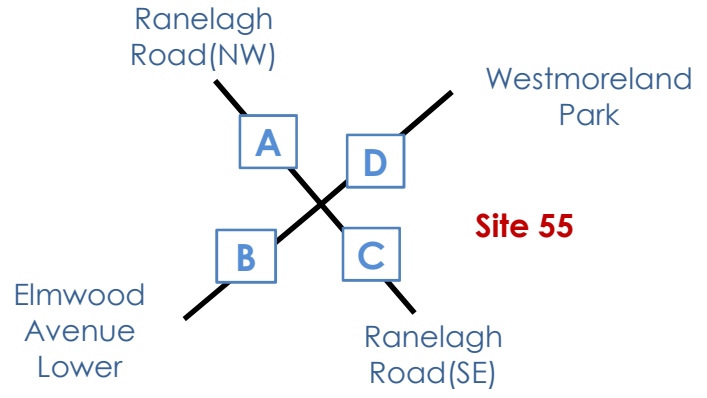
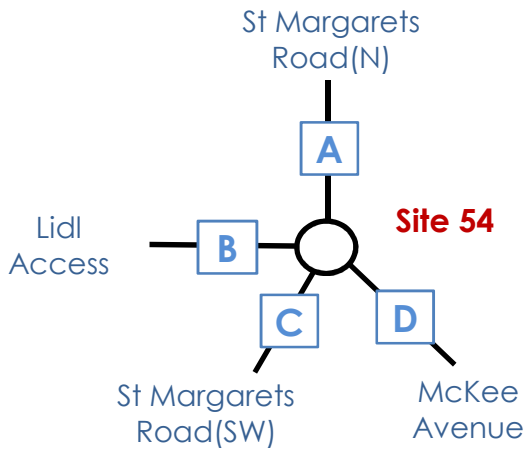

| | | | | | | | |
|--------------------------|---|-----------------------|------|------------------------------------|---------|------------------|----|
| Sites / Location: | 54 to 57 / Dublin | Project No: | 5103 | Drawing No: | 5103-14 | Drawn By: | AC |
| Survey Date: | Site 54: Tuesday 12th May 2015 Sites 55 & 56: Thursday 7th May 2015 Site 57: Wednesday 6th May 2015 | Project Name: | | DCC COUNTS 2015 | | | |
| Survey Times: | 07:00 to 19:00 | Drawing Title: | | Site Layout and Observed Movements | | | |

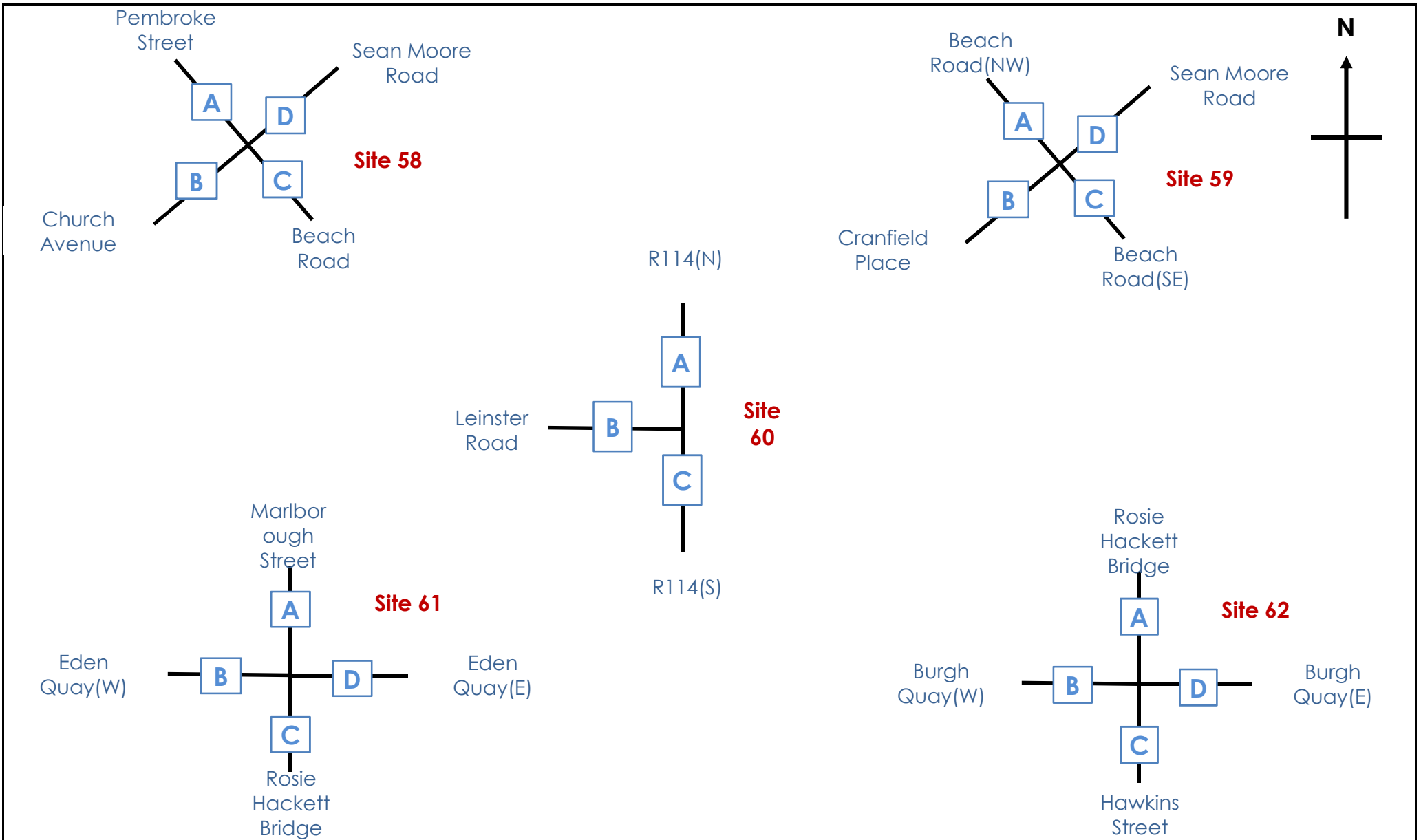

| | | | | | |
|---|--|--|----------------------------|---------------------|--|
|  | Sites / Location: 58 to 62 / Dublin | Project No: 5103 | Drawing No: 5103-15 | Drawn By: AC | |
| | Survey Date: Sites 58 & 59: Wednesday 6th May 2015 Sites 60 to 62: Thursday 7th May 2015 | Project Name: DCC COUNTS 2015 | | | |
| | Survey Times: 07:00 to 19:00 | Drawing Title: Site Layout and Observed Movements | | | |